

# evOLUTION®

evolutionpowertools.com

**R355**  
**CPS**

Original Instructions

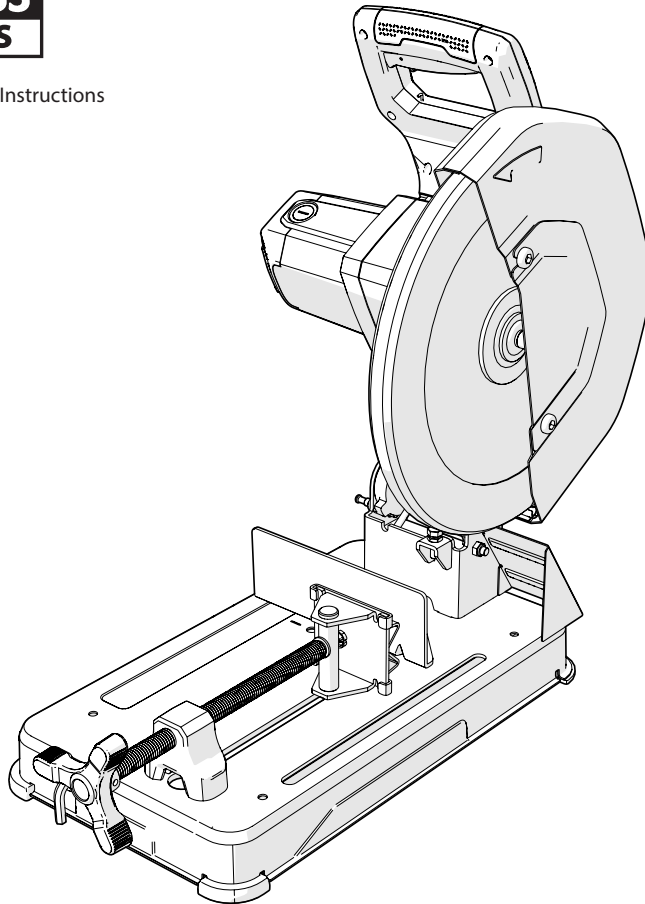

Originally written in UK English

Date Published:14/06/2019

**(1.2) INTRODUCTION**  
**IMPORTANT**

Please read these operating and safety instructions carefully and completely.

For your own safety, if you are uncertain about any aspect of using this equipment please access the relevant Technical Helpline, the number of which can be found on the Evolution Power Tools website. We operate several Helplines throughout our worldwide organization, but Technical help is also available from your supplier.

**(1.3) CONTACT**

Web: [www.evolutionpowertools.com](http://www.evolutionpowertools.com)  
UK: [enquiries@evolutionpowertools.com](mailto:enquiries@evolutionpowertools.com)  
USA: [evolutioninfo@evolutionpowertools.com](mailto:evolutioninfo@evolutionpowertools.com)

**(1.4) WARRANTY**

Congratulations on your purchase of an Evolution Power Tools Machine. Please complete your product registration 'online' as explained in the registration leaflet included with this machine. This will enable you to validate your machine's warranty period via Evolutions website by entering your details and thus ensure prompt service if ever needed.

We sincerely thank you for selecting a product from Evolution Power Tools.

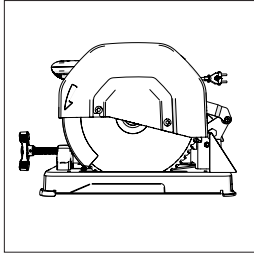

Fig. 1

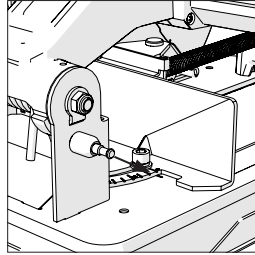

Fig. 2

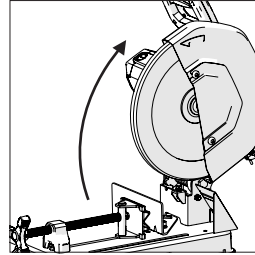

Fig. 3

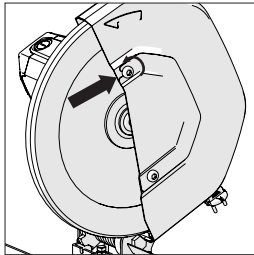

Fig. 4

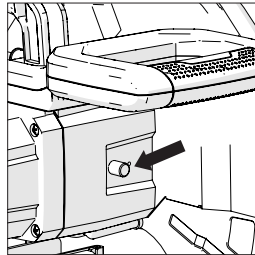

Fig. 5

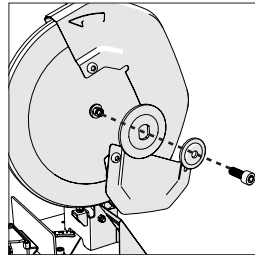

Fig. 6

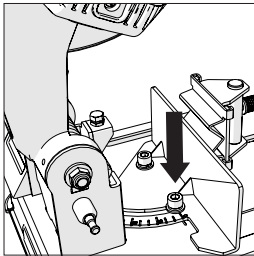

Fig. 7

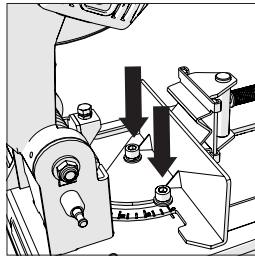

Fig. 8

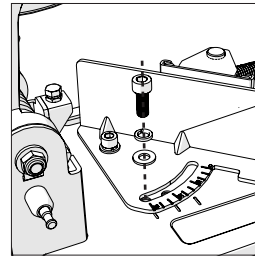

Fig. 9

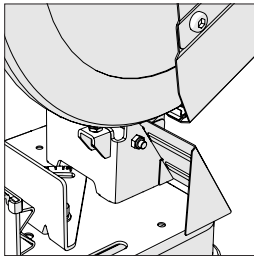

Fig. 10

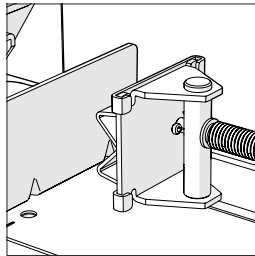

Fig. 11

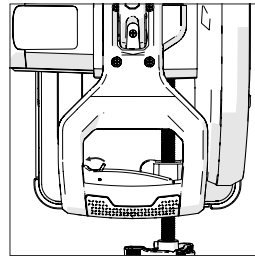

Fig. 12

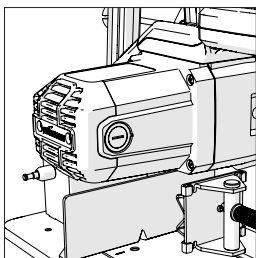

Fig. 13

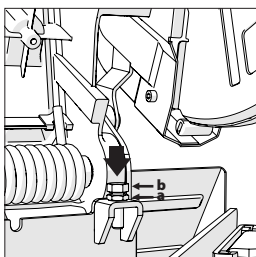

Fig. 14

SPECIFICATIONS		R355CPS	
MACHINE	METRIC	IMPERIAL	
Motor (UK/EU) 220V-240V ~ 50Hz	2200W		
Motor (UK) 110V ~ 50Hz	1600W		
Motor (USA) 120V ~ 60Hz	15A		
Motor (AUS) 240V ~ 50Hz	2200W		
Speed (No Load) @ 110V	1550 min <sup>-1</sup>	1550 rpm	
Speed (No Load) @ 120V	1450 min <sup>-1</sup>	1450 rpm	
Speed (No Load) @ 220-240V	1550 min <sup>-1</sup>	1550 rpm	
Weight (With Blade)	21.5 kg	47 lbs	
Power Cord	2 m	6 feet	
CUTTING CAPACITY			
Mild Steel Plate (Max. Thickness)	6mm	1/4"	
Stainless Steel Plate (Max. Thickness)	N/A	N/A	
Square Tube at 90°	120 x 120mm	4-3/4" x 4-3/4"	
Square Tube at 45°	89 x 89mm	3-1/2" x 3-1/2"	
Rectangle Tube at 90°	95 x 180mm	3-3/4" x 7-1/8"	
Rectangle Tube at 45°	78 x 110mm	3-1/8" x 4-3/8"	
Round Tube at 90°	Ø 130mm	Ø 5-1/8"	
Round Tube at 45°	Ø 105mm	Ø 4-1/8"	
Minimum Cut Off Piece Length	8mm	5/16"	
BLADE			
Diameter	355mm	14"	
Bore	25.4mm	1"	
Kerf	2.2mm	0-3/32"	
NOISE EMISSION DATA*			
Sound Pressure Level L <sub>PA</sub>	110V: 100,5dB(A), K=3dB(A) / 220-240V: 97,3dB(A), K=3dB(A)		
Sound Power Level L <sub>WA</sub>	110V: 111,5dB(A), K=3dB(A) / 220-240V: 108,3dB(A), K=3dB(A)		
MODELS			
United Kingdom	(230V) 083-0001, (110v) 083-0002		
United States	(120V) 083-0004		
Europe	(230V) 083-0003		
Australia	(230V) 083-0006		

**WARNING:** Due to the power input of this product on start up, voltage drops may occur and this can influence other equipment (e.g. dimming lights). So for technical reasons we advise, if the mains-impedance is  $Z_{max} < 0.264\Omega$ , these disturbances are not expected. If you require further clarification, you may contact your local power supply authority.

**POLARIZED PLUG**

**WARNING (USA ONLY):** To reduce the risk of electric shock, this equipment has a polarized plug (one blade is wider than the other). This plug will fit in a polarized outlet only one way. If the plug does not fit fully in the outlet, reverse the plug. If it still does not fit, contact a qualified electrician to install the proper outlet. Do not change the plug in any way.

**(1.6) VIBRATION**

**Note:** The vibration measurement was made under standard conditions in accordance with: EN 62841-1: 2015 & EN 62841-3-10:2015.

- The declared vibration total value(s) and the declared noise emission value(s) have been measured in accordance with a standard test method and may be used for comparing one tool with another;
- The declared vibration total value(s) and the declared noise emission value(s) may also be used in a preliminary assessment of exposure.

**WARNING:**

- that the vibration and noise emissions during actual use of the power tool can differ from the declared values depending on the ways in which the tool is used especially what kind of workpiece is processed; and
- of the need to identify safety measures to protect the operator that are based on an estimation of exposure in the actual conditions of use (taking account of all parts of the operating cycle such as the times when the tool is switched off and when it is running idle in addition to the trigger time).

**(1.7) WARNING:** When using this machine the operator can be exposed to high levels of vibration transmitted to the hand and arm. It is possible that the operator could develop "Vibration white finger disease" (Raynaud syndrome). This condition can reduce the sensitivity of the hand to temperature as well as producing general numbness. Prolonged or regular users of this machine should monitor the condition of their hands and fingers closely. If any of the symptoms become evident, seek immediate medical advice.

- The measurement and assessment of human exposure to hand-transmitted vibration in the workplace is given in: BS EN ISO 5349-1:2001 and BS EN ISO 5349-2:2002.
- Many factors can influence the actual vibration level during operation e.g. the work surfaces condition and orientation and the type and condition of the machine being used. Before each use, such factors should be assessed, and where possible appropriate working practices adopted.

**(1.8) LABELS & SYMBOLS**

**WARNING:** Do not operate this machine if warning and/or instruction labels are missing or damaged. Contact Evolution Power Tools for replacement labels.

**Note:** All or some of the following symbols may appear in the manual or on the product.

(1.9)

Symbol	Description
V	Volts
A	Amperes
Hz	Hertz
Min <sup>-1</sup> / RPM	Speed
~	Alternating Current
n <sub>0</sub>	No Load Speed
	Wear Safety Goggles
	Wear Ear Protection
	Wear Dust Protection
	Read Instructions
	Wear Protective Gloves
	Double Insulation Protection
	CE Certification
	ETL Intertek Certification
	Waste electrical and electronic equipment
	Warning
	(RCM) Regulatory Compliance Mark for electrical and electronic equipment. Australian/New Zealand Standard 5490

**(1.10) INTENDED USE OF THIS POWER TOOL**

**WARNING:** This product has been designed to be used with special Evolution blades. Only use accessories designed for use in this machine and/or those recommended specifically by Evolution Power Tools Ltd. When fitted with an appropriate blade this machine can be used to cut:

**Mild Steel  
Thin Steel  
Stainless Steel  
Aluminium  
Wood  
Masonry**

**Note:** Cutting galvanised steel may reduce blade life.

**(1.15) OUTDOOR USE**

**WARNING:** For your protection if this tool is to be used outdoors it should not be exposed to rain, or used in damp locations. Do not place the tool on damp surfaces. Use a clean, dry workbench if available. For added protection use a residual current device (R.C.D.) that will interrupt the supply if the leakage current to earth exceeds 30mA for 30ms. Always check the operation of the residual current device (R.C.D.) before using the machine.

If an extension cable is required it must be a suitable type for use outdoors and so labelled.

The manufacturers instructions should be followed when using an extension cable.

**(2.1) GENERAL POWER TOOL SAFETY INSTRUCTIONS**

(These General Power Tool Safety Instructions are as specified in EN 62841-1:2015 & EN 62841-3-10:2015.

**⚠ WARNING:** Read all safety warnings and instructions. Failure to follow the warnings and instructions may result in electric shock, fire and/ or serious injury.

Save all warnings and instructions for future reference. The term "power tool" in the warnings refers to your mains-operated (corded) power tool or battery-operated (cordless) power tool.

**(2.2) 1) General Power Tool**

**Safety Warnings [Work area safety]**

**a) Keep work area clean and well lit.**

Cluttered or dark areas invite accidents.  
**b) Do not operate power tools in explosive atmospheres, such as in the presence of flammable liquids, gasses or dust.** Power tools create sparks which may ignite the dust or fumes.

**c) Keep children and bystanders away while operating power tool.** Distractions can cause

you to lose control.

**(2.3) 2) General Power Tool Safety Warnings [Electrical Safety]**

**a) Power tool plugs must match the outlet.**

Never modify the plug in any way. Do not use any adapter plugs with earthed (grounded) power tools. Unmodified plugs and matching outlets will reduce the risk of electric shock.

**b) Avoid body contact with earthed or grounded surfaces, such as pipes, radiators, ranges and refrigerators.** There is an increased risk of electric shock if your body is earthed or grounded.

**c) Do not expose power tools to rain or wet conditions.** Water entering a power tool will increase the risk of electric shock.

**d) Do not abuse the cord. Never use the cord for carrying, pulling or unplugging the power tool.** Keep cord away from heat, oil, sharp edges or moving parts. Damaged or entangled cords increase the risk of electric shock.

**e) When operating a power tool outdoors, use an extension cord suitable for outdoor use.**

Use of a cord suitable for outdoor use reduces the risk of electric shock.

**f) If operating a power tool in a damp location is unavoidable, use a residual current device (RCD) protected supply.**

Use of an RCD reduces the risk of electric shock.

**(2.4) 3) General Power Tool Safety Warnings [Personal Safety].**

**a) Stay alert, watch what you are doing and use common sense when operating a power tool.** Do not use a power tool while you are tired or under the influence of drugs, alcohol or medication. A moment of inattention while operating power tools may result in serious personal injury.

**b) Use personal protective equipment.** Always wear eye protection. Protective equipment such as dust masks, non-skid safety shoes, hard hat or hearing protection used for appropriate conditions will reduce personal injuries.

**c) Prevent unintentional starting.** Ensure the switch is in the off-position before connecting to power source and or battery pack, picking up or carrying the tool. Carrying power tools with your finger on the switch or energising the power tools that have the switch on invites accidents.

**d) Remove any adjusting key or wrench before turning the power tool on.** A wrench or key left attached to a rotating part of a power tool may result in personal injury.

**e) Do not overreach. Keep proper footing and balance at all times.** This enables better control of the power tool in unexpected situations.

**f) Dress properly.** Do not wear loose clothing or jewellery. Keep your hair, clothing and gloves away from moving parts. Loose clothes, jewellery or long hair can be caught in moving parts.

**g) If devices are provided for the connection of dust extraction and collection facilities, ensure that these are connected and properly**

**used.** Use of dust collection can reduce dust-related hazards.

**h) Do not let familiarity gained from frequent use of tools allow you to become complacent and ignore tool safety principles.** A careless action can cause severe injury within a fraction of a second.

**(2.5) 4) General Power Tool Safety Warnings [Power tool use and care].**

**a) Do not force the power tool.** Use the correct power tool for your application. The correct power tool will do the job better and safer at a rate for which it was designed.

**b) Do not use the power tool if the switch does not turn it on or off.** Any power tool that cannot be controlled with the switch is dangerous and must be repaired.

**c) Disconnect the power tool from the power source and/or battery pack from the power tool before making any adjustments, changing accessories, or storing power tools.** Such preventative safety measures reduce the risk of starting the power tool accidentally.

**d) Store idle power tools out of the reach of children and do not allow persons unfamiliar with the power tool or these Instructions to operate the power tool.** Power tools are dangerous in the hands of untrained users.

**e) Maintain power tools.** Check for misalignment or binding of moving parts, breakage of moving parts and any other condition that may affect the power tools operation. If damaged, have the power tool repaired before use. Many accidents are caused by poorly maintained power tools.

**f) Keep cutting tools sharp and clean.** Properly maintained cutting tools with sharp cutting edges are less likely to bind and are easier to control.

**g) Use the power tool, accessories and tool bits etc. in accordance with these instructions, taking into account the working conditions and the work to be performed.** Use of the power tool for operations different from those intended could result in a hazardous situation.

**h) Keep handles and grasping surfaces dry, clean and free from oil and grease.** Slippery handles and grasping surfaces do not allow for safe handling and control of the tool in unexpected situations.

**(2.6) 5) General Power Tool Safety Warnings [Service]**

**a) Have your power tool serviced by a qualified repair person using only identical replacement parts.** This will ensure that the safety of the power tool is maintained.

**(2.7) HEALTH ADVICE**

**WARNING:** When using this machine, dust particles may be produced. In some instances, depending on the materials you are working with, this dust can be particularly

harmful. If you suspect that paint on the surface of material you wish to cut contains lead, seek professional advice. Lead based paints should only be removed by a professional and you should not attempt to remove it yourself.

Once the dust has been deposited on surfaces, hand to mouth contact can result in the ingestion of lead. Exposure to even low levels of lead can cause irreversible brain and nervous system damage. The young and unborn children are particularly vulnerable.

You are advised to consider the risks associated with the materials you are working with and to reduce the risk of exposure.

As some materials can produce dust that may be hazardous to your health, we recommend the use of an approved face mask with replaceable filters when using this machine.

**You should always:**

- Work in a well-ventilated area.
- Work with approved safety equipment, such as dust masks that are specially designed to filter microscopic particles.

**(2.8) WARNING:** The operation of any power tool can result in foreign objects being thrown towards your eyes, which could result in severe eye damage. Before beginning power tool operation, always wear safety goggles or safety glasses with side shield or a full face shield where necessary.

**(3.0) Cut-off machine safety warnings**

**a) Position yourself and bystanders away from the plane of the rotating wheel.** The guard helps to protect the operator from broken wheel fragments and accidental contact with wheel.

**b) Use only bonded reinforced or diamond cut-off wheels for your power tool.** Just because an accessory can be attached to your power tool, it does not assure safe operation. Use only Evolution carbide tipped blades when cutting woods, metals and plastics or Evolution diamond blades when cutting stone or masonry with your power tool.

**NOTE:** The wording "bonded reinforced" or "diamond" is used as applicable depending on the designation of the tool.

**c) The rated speed of the accessory must be at least equal to the maximum speed marked on the power tool.** Accessories running faster than their rated speed can break and fly apart.

**d) Wheels must be used only for recommended applications.** For example: do not grind with the side of a cut-off wheel. Abrasive cut-off wheels are intended for peripheral grinding, side forces applied to these wheels may cause them to shatter.

**e) Always use undamaged wheel flanges that are of correct diameter for your selected wheel.** Proper wheel flanges support

the wheel thus reducing the possibility of wheel breakage.

**f) The outside diameter and the thickness of your accessory must be within the capacity rating of your power tool.** Incorrectly sized accessories cannot be adequately guarded or controlled.

**g) The arbour size of wheels and flanges must properly fit the spindle of the power tool.** Wheels and flanges with arbour holes that do not match the mounting hardware of the power tool will run out of balance, vibrate excessively and may cause loss of control.

**h) Do not use damaged wheels.** Before each use, inspect the wheels for chips and cracks. If the power tool or wheel is dropped, inspect for damage or install an undamaged wheel. After inspecting and installing the wheel, position yourself and bystanders away from the plane of the rotating wheel and run the power tool at maximum no load speed for one minute. Damaged wheels will normally break apart during this test time.

**i) Wear personal protective equipment.** Depending on application, use face shield, safety goggles or safety glasses. As appropriate, wear dust mask, hearing protectors, gloves and shop apron capable of stopping small abrasive or workpiece fragments. The eye protection must be capable of stopping flying debris generated by various operations. The dust mask or respirator must be capable of filtering particles generated by your operation. Prolonged exposure to high intensity noise may cause hearing loss.

**j) Keep bystanders a safe distance away from work area.** Anyone entering the work area must wear personal protective equipment. Fragments of workpiece or of a broken wheel may fly away and cause injury beyond immediate area of operation.

**k) Position the cord clear of the spinning accessory.** If you lose control, the cord may be cut or snagged and your hand or arm may be pulled into the spinning wheel.

**l) Regularly clean the power tool's air vents.** The motor's fan can draw the dust inside the housing and excessive accumulation of powdered metal may cause electrical hazards.

**m) Do not operate the power tool near flammable materials.** Do not operate the power tool while placed on a combustible surface such as wood. Sparks could ignite these materials.

**n) Do not use accessories that require liquid coolants.** Using water or other liquid coolants may result in electrocution or shock.

**(3.1) Maintain a firm grip on the power tool and position your body and arm to allow you to resist kickback forces.** The operator can control upward kickback forces, if proper precautions are taken.

**b) Do not position your body in line with the**

**rotating wheel.** If kickback occurs, it will propel the cutting unit upwards toward the operator.

**c) Do not attach a saw chain, woodcarving blade, segmented diamond wheel with a peripheral gap greater than 10mm or toothed saw blade.** Such blades create frequent kickback and loss of control.

**d) Do not "jam" the wheel or apply excessive pressure.** Do not attempt to make an excessive depth of cut. Overstressing the wheel increases the loading and susceptibility to twisting or binding of the wheel in the cut and the possibility of kickback or wheel breakage.

**e) When the wheel is binding or when interrupting a cut for any reason, switch off the power tool and hold the cutting unit motionless until the wheel comes to a complete stop.** Never attempt to remove the wheel from the cut while the wheel is in motion otherwise kickback may occur. Investigate and take corrective action to eliminate the cause of wheel binding.

**f) Do not restart the cutting operation in the workpiece.** Let the wheel reach full speed and carefully re-enter the cut. The wheel may bind, walk up or kickback if the power tool is restarted in the workpiece.

**g) Support any oversized workpiece to minimize the risk of wheel pinching and kickback.** Large workpieces tend to sag under their own weight. Supports must be placed under the workpiece near the line of cut and near the edge of the workpiece on both sides of the wheel.

### **(3.2) Causes and operator prevention of kickback:**

Kickback is a sudden reaction to a pinched, bound or misaligned saw blade, causing an uncontrolled saw to lift up and out of the workpiece toward the operator:

- 1. When the blade is pinched or bound tightly by the kerf closing down, the blade stalls and the motor reaction drives the unit rapidly back toward the operator;**
- 2. If the blade becomes twisted or misaligned in the cut, the teeth at the back edge of the blade can dig into the top surface of the workpiece causing the blade to climb out of the kerf and jump back towards the operator.**

### **(3.3) Kickback and related warnings**

Kickback is a sudden reaction to a pinched or snagged rotating wheel. Pinching or snagging causes rapid stalling of the rotating wheel which in turn causes the uncontrolled cutting unit to be forced upwards toward the operator.

For example, if an abrasive wheel is snagged or pinched by the workpiece, the edge of the wheel that is entering into the pinch point can dig into the surface of the material causing



the wheel to climb out or kick out. Abrasive wheels may also break under these conditions. Kickback is the result of power tool misuse and/or incorrect operating procedures or conditions and can be avoided by taking proper precautions as given below.

- a) **Maintain a firm grip on the power tool and position your body and arm to allow you to resist kickback forces.** The operator can control upward kickback forces, if proper precautions are taken.
- b) **Do not position your body in line with the rotating wheel.** If kickback occurs, it will propel the cutting unit upwards toward the operator.
- c) **Do not attach a saw chain, woodcarving blade, segmented diamond wheel with a peripheral gap greater than 10mm or toothed saw blade.** Such blades create frequent kickback and loss of control.
- d) **Do not "jam" the wheel or apply excessive pressure.** Do not attempt to make an excessive depth of cut. Overstressing the wheel increases the loading and susceptibility to twisting or binding of the wheel in the cut and the possibility of kickback or wheel breakage.
- e) **When the wheel is binding or when interrupting a cut for any reason, switch off the power tool and hold the cutting unit motionless until the wheel comes to a complete stop.** Never attempt to remove the wheel from the cut while the wheel is in motion otherwise kickback may occur. Investigate and take corrective action to eliminate the cause of wheel binding.
- f) **Do not restart the cutting operation in the workpiece.** Let the wheel reach full speed and carefully re-enter the cut. The wheel may bind, walk up or kickback if the power tool is restarted in the workpiece.
- g) **Support any oversized workpiece to minimize the risk of wheel pinching and kickback.** Large workpieces tend to sag under their own weight. Supports must be placed under the workpiece near the line of cut and near the edge of the workpiece on both sides of the wheel.

(3.4) **WARNING:** If any parts are missing, do not operate your machine until the missing parts are replaced. Failure to follow this rule could result in serious personal injury.

#### ADDITIONAL WARNINGS

1. **Keep guards in place** and in working order.
2. **Remove adjusting keys and wrenches.** Form habit of checking to see that keys and adjusting wrenches are removed from tool before turning it on.
3. **Keep work area clean.** Cluttered areas and benches invite accidents.
4. **Don't use in dangerous environment.** Don't use power tools in damp or wet locations, or expose them to rain. Keep work area well lit.

5. **Keep children away.** All visitors should be kept safe distance from work area.

6. **Make workshop child proof** with padlocks, master switches, or by removing starter keys.

7. **Don't force the tool.** It will do the job better and safer at the rate for which it was designed.

8. **Use the right tool.** Don't force the tool or attachment to do a job for which it was not designed.

9. **Use proper extension cord.** Make sure your extension cord is in good condition. When using an extension cord, be sure to use one heavy enough to carry the current your product will draw. An undersized cord will cause a drop in line voltage resulting in loss of power and overheating. The table on the next page shows the correct size to use depending on cord length and nameplate ampere rating. If in doubt, use the next heavier gauge. The smaller the gauge number, the heavier the cord.

10. **Wear proper apparel** do not wear loose clothing, gloves, neckties, rings, bracelets, or other jewellery which may get caught in moving parts. Nonslip footwear is recommended. Wear protective hair covering to contain long hair.

11. **Always use safety glasses.** Also use face or dust mask if cutting operation is dusty. Everyday eyeglasses only have impact resistant lenses, they are not safety glasses.

12. **Secure work.** Use clamps or a vise to hold work when practical. It's safer than using your hand and it frees both hands to operate tool.

13. **Don't overreach.** Keep proper footing and balance at all times.

14. **Maintain tools with care.** Keep tools sharp and clean for best and safest performance. Follow instructions for lubricating and changing accessories.

15. **Disconnect tools** before servicing; when changing accessories, such as blades, bits, cutters, and the like.

16. **Reduce the risk of unintentional staling.** Make sure switch is in off position before plugging in.

17. **Use recommended accessories.** Consult the owner's manual for recommended accessories. The use of improper accessories may cause risk of injury to persons.

18. **Never stand on the tool** serious injury could occur if the tool is tipped or if the cutting tool is unintentionally contacted.

19. **Check damaged parts.** Before further use of the tool, a guard or other part that is damaged should be carefully checked to determine that it will operate properly and perform its intended function - check for alignment of moving parts, binding of moving parts, breakage of parts, mounting, and any other conditions that may affect its operation. A guard or other part that is damaged should be properly repaired or replaced.

20. **Direction of feed.** Feed work into a blade or cutter against the direction of rotation of the blade or cutter only.

**21. Never leave tool running unattended.**  
Turn power off. Don't leave the tool until it comes to a complete stop.

**(4.1) GETTING STARTED - UNPACKING**

**Caution:** This packaging contains sharp objects. Take care when unpacking. Remove the machine, together with the accessories supplied from the packaging. Check carefully to ensure that the machine is in good condition and account for all the accessories listed in this manual. Also make sure that all the accessories are complete.

If any parts are found to be missing, the machine and its accessories should be returned together in their original packaging to the retailer.

Do not throw the packaging away; keep it safe throughout the guarantee period. Dispose of the packaging in an environmentally responsible manner. Recycle if possible. Do not let children play with empty plastic bags due to the risk of suffocation.

**SERIAL NO. / BATCH CODE**

The serial number can be found on the motor housing of the machine.

For instructions on how to identify the batch code, please contact the Evolution Power Tools helpline or go to:  
[www.evolutionpowertools.com](http://www.evolutionpowertools.com)

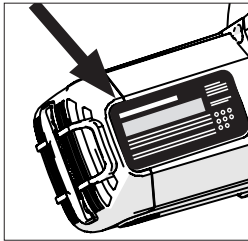

**(4.2) ITEMS SUPPLIED**

Description	Quantity
R355CPS Saw	1
Instruction Manual	1
14" (355mm) Multi-Material TCT Blade	1
Hex Key 8mm (Blade Change)	1
V-Block	1

**(4.4) REPLACEMENT BLADES**

Description	Part No
14" (355mm) Multi-Material Cutting TCT Blade	(UK/EU) RAGEBLADE-355MULTI (USA) RAGE355BLADE
14" (355mm) Diamond Blade	(UK/EU) RAGEBLADE-355DIAMOND (USA) 14BLADEDM
14" (355mm) Mild Steel Cutting Blade	(UK/EU) 66TBLADE (USA) 14BLADEST
14" (355mm) Stainless Steel Cutting Blade	(UK/EU) 90TBLADE (USA) 14BLADESS
14" (355mm) Thin Steel Cutting Blade	(UK/EU) EVO-BLADE355STS (USA) 14BLADETS
14" (355mm) Aluminium/Aluminum Cutting Blade	(UK/EU) 80TBLADE14 (USA) 14BLADEAL
14" (355mm) Wood Cutting Blade	(USA) 14BLADEWD
15" (380mm) Mild Steel Cutting Blade	(USA) 15BLADEST

**NOTE:** This machine is supplied with 2 accessories. The 8mm hex key should be kept in the dedicated tool storage located in the front of the base when not in use. The V-block adaptor should be used where possible, and kept safely away from the machine when not in use.

**MACHINE OVERVIEW**

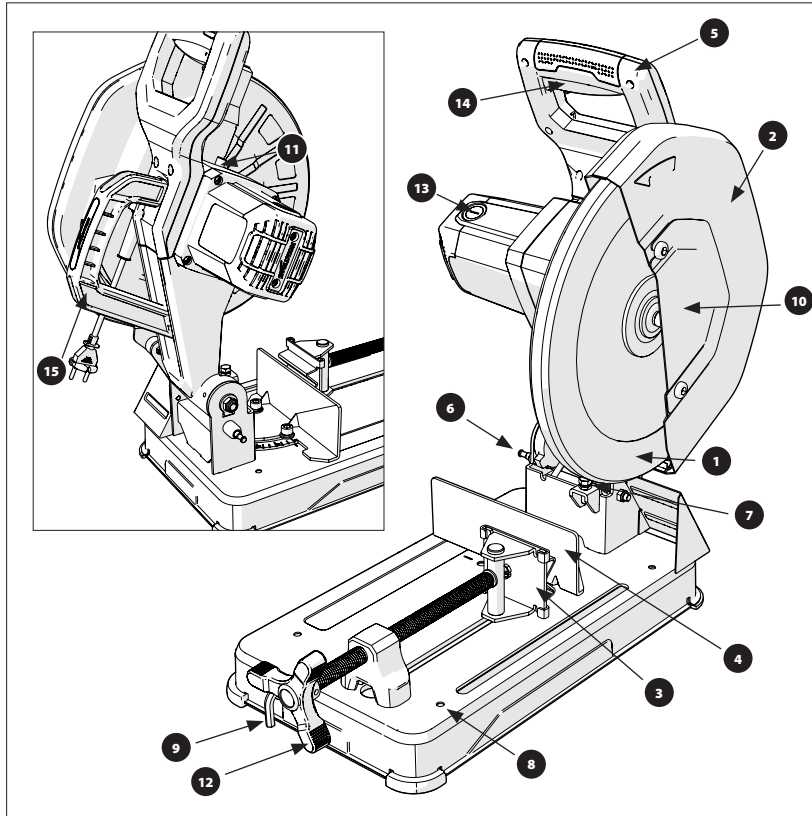

- |                                 |                               |
|---------------------------------|-------------------------------|
| 1. LOWER BLADE GUARD            | 13. CARBON BRUSHES ACCESS CAP |
| 2. UPPER BLADE GUARD            | 14. ON/OFF TRIGGER SWITCH     |
| 3. FRONT SWIVELLING VICE JAW    | 15. CARRY HANDLE              |
| 4. REPOSITIONABLE REAR VICE JAW |                               |
| 5. CUTTING HANDLE               |                               |
| 6. CUTTING HEAD HOLD DOWN PIN   |                               |
| 7. TRAVEL STOP ADJUSTMENT SCREW |                               |
| 8. WORK BENCH MOUNTING HOLES X4 |                               |
| 9. BLADE CHANGE HEX KEY         |                               |
| 10. BLADE ARBOR GUARD           |                               |
| 11. ARBOR LOCK BUTTON           |                               |
| 12. VICE HANDLE                 |                               |

**(5.5) ASSEMBLY & PREPARATION**

**PERMANENTLY MOUNTING A CHOP SAW**

**WARNING:** Only attempt the following procedures with the machine disconnected from the mains power supply.

The base on this chop saw has four mounting holes (in the corners) through which suitable bolts (not supplied) can be placed to secure the machine.

Site the machine giving consideration to the following guidelines:

- To avoid injury from flying debris, position the saw so that other people or bystanders cannot stand too close (or behind) it.
- Locate the saw on a firm, level surface where there is plenty of room for handling and properly supporting the workpiece.
- Ensure that the workbench or other supporting structure is firm and stable and does not 'rock'.
- Ensure that the power cord cannot become entangled with any part of the machine during cutting operations.
- Ensure that the power cord is routed in such a way that it does not pose a trip (or any other type) of hazard to the operator or any bystanders.

**TRANSPORTING THE SAW**

Only transport these machines with the Cutting Head in the locked down position (**Fig. 1**) and the Locking Pin fully engaged in its socket.

**UNLOCKING THE CUTTING HEAD**

**NOTE:** We recommend that the operator keep hold of the cutting handle throughout this process to ensure a controlled transition of the cutting head to the upper position.

- Gently press down on the Cutting Handle. Pull out the Locking Pin. (**Fig. 2**) Allow the Cutting Head to rise to its upper position (**Fig. 3**).

**REMOVING OR INSTALLING A BLADE**

**WARNING:** Only use genuine Evolution blades designed for this machine - **see page 10**

It is recommended that the operator considers wearing protective gloves when handling the

blade during installation or when changing the machines blade.

**REMOVING A BLADE:**

- Ensure that the Cutting Head is in its upper position.
- Using the Hex Key supplied, loosen the front arbor cover bolt and rotate the arbor cover out of the way. (**Fig. 4**).
- Press the arbor lock button (labelled) (**Fig. 5**) and use the supplied hex key to remove the blade bolt. The blade may rotate slightly until the arbor lock engages.
- Remove the arbor bolt, washer and outer blade flange. (**Fig. 6**).
- Open the blade guard and carefully remove the old blade. Leave the inner blade flange in place.

**INSTALLING A BLADE:**

- Install the new blade, ensuring the directional arrow on the blade matches the direction of the arrow on the upper blade guard.
- Allow the blade guard to close and refit the outer blade flange and washer.
- Partially refit the arbor bolt, press the arbor lock button and fully tighten with the supplied hex key.

After replacing a blade, always run the machine, without load to ensure the blade is seated correctly.

**CUTTING ANGLE ADJUSTMENT**

**TO ANGLE THE REAR VICE JAW:**

- Loosen the fence securing bolt (**Fig. 7**)
- Rotate the fence to the desired angle and retighten the bolt.

**TO REMOVE THE REAR VICE JAW:**

Completely remove fence securing bolts and washers. (**Fig. 8**)

- Completely remove both fence securing bolts, washer and spacer (**Fig. 9**) that secure the rear vice jaw to the machines base.
- Place the vice jaw into its new service position.
- Refit the fence securing bolts, washers and spacer.

**CHIP COLLECTION**

A specially shaped steel shield (**Fig. 10**) prevents the cut debris from being expelled forcefully from the machine.

The accumulated chippings behind the machine will need to be removed from on a regular basis.

**WARNING:** Some of the chippings may be sharp, or in other ways pose a hazard to the operator. It may be necessary for the operator to wear suitable PPE.

Dispose of the collected chippings in an environmentally responsible way.

**WARNING:** Only clear chippings from the machine with the machine disconnected from the mains power supply.

### OPERATING ADVICE (PRE OPERATION CHECKS)

**NOTE:** As all operating environments are unique and diverse, Evolution Power Tools offers the following general advice on safe operational procedures and practices for consideration by the operator.

This advice cannot be exhaustive as Evolution has no influence on the type of workshops or working environments in which these machines may be used.

We recommend that the operator seeks advice from a competent authority or the workshop supervisor if they are at unsure about any aspect of using these machines.

It is important that routine safety checks are carried out (at each time of usage) before the operator uses the machine.

**WARNING:** These pre-use safety checks should be carried out with the machine disconnected from the mains power supply.

- Check that all safety guards are operating correctly, and that all adjustment handles/screws are securely tightened.
- Check that the blade is secure and installed correctly. Also check that it is the correct blade for the material being cut.
- Check the security of the workpiece in the machine.
- Check the integrity of the power cord and its position and routing.

### PPE

The operator should wear all relevant PPE (**Personal Protection Equipment**) necessary for the task ahead. This could include safety glasses, dust masks, safety shoes etc.

### PREPARING TO MAKE A CUT

**WARNING:** Do not overreach. Keep good footing and balance. Stand to one side so that your face

and body are out of line of a possible kickback.

**WARNING: Freehand** cutting is a major cause of accidents and **should not be attempted.**

- Open the vice and position the workpiece as required. Rotate the vice handle clockwise until the workpiece is securely clamped. Check that the workpiece cannot move before making the cut.
- The machines base should be clean and free from any 'swarf' or sawdust etc. before the workpiece is clamped into position.
- Ensure that the workpiece is firmly secured in the vice.
- Ensure that the 'cut-off' material is free to move sideways away from the blade when the cut is completed.
- Ensure that the 'cut-off' piece cannot become 'jammed' in any other part of the machine.
- Do not use these saws to cut small pieces.

If the workpiece being cut could cause your hand or fingers to come within 150mm of the saw blade, the workpiece is too small.

Angles should be clamped in an inverted position. The supplied 'V' block (**Fig. 11**) can be attached to a vice jaw to provide increased clamping contact of (particular tubular) round, angle and some square or rectangular section workpieces.

### THE ON/OFF TRIGGER SWITCH

These models are equipped with a none latching safety start trigger switch.

### TO START THE MOTOR:

- Push in the safety lock on the left side of the trigger switch to the left (**Fig. 12**).
- Depress the main trigger switch.

**WARNING:** Never start the saw with the cutting edge of the saw blade in contact with the workpiece surface.

### MAKING A CUT

- With the Cutting Head in the upper position, switch on the motor and allow it to reach full operational speed.
- Gently lower the Cutting Head to the material and use light pressure at first to prevent the blade from grabbing. Do not 'force' the machine. Let the saw blade do the work.
- Cutting performance will not improve by applying undue pressure on the machine, and doing so may cause blade and motor life to be reduced.

- Reduce the pressure as the blade begins to exit the material.

On completion of a cut release the ON/OFF trigger switch to turn off the motor.

- Allow the Cutting Head to return to its upper position.
- Only remove your hands, or the workpiece from the machine, after the motor has completely stopped and the stationary blade is covered by the lower blade guard.

**WARNING:** These machines must never be used to cut Asbestos or any material that contains, or is suspected to contain, Asbestos. Consult/inform the relevant authorities, and seek additional guidance if Asbestos contamination is suspected.

#### MAINTENANCE & ADJUSTMENTS

**NOTE:** Any maintenance must be carried out with the machine switched off and disconnected from the mains power supply.

- Check on a regular basis that all safety features and guards etc are operating correctly.
- All motor bearings in this machine are lubricated for life. No further lubrication is required.
- Use a clean, slightly damp cloth to clean the plastic parts of the machine. Do not use solvents or similar products which could damage the plastic parts.
- The machines air vents should be cleaned using compressed dry air only.

#### CHECKING/REPLACING THE CARBON BRUSHES

Excessive sparking may indicate the presence of dirt in the motor or worn out carbon brushes. Disconnect the machine from the power supply before attempting to check or replace the Carbon Brushes.

Replace both carbon brushes if either has less than 6mm length of carbon remaining, or if the spring or wire is damaged or burned.

#### TO REMOVE THE BRUSHES:

- Unscrew the plastic caps found at the back of the motor (**Fig. 13**). Be careful as the caps are spring-loaded.
- Withdraw the brushes with their springs.
- If replacement is necessary renew the brushes and replace the caps.

Used but serviceable brushes can be replaced, but only as long as they are returned to the same position, and inserted the same way round, as they were removed from the machine.

- Run new brushes without load for approximately 5 minutes. This will help the bedding-in process.

#### CUTTING HEAD TRAVEL ADJUSTMENT

To prevent the blade from contacting any part of the machines metal base, the downward travel of the Cutting Head can be adjusted.

Lower the Cutting Head and check for any blade contact with the machines base.

If the downward travel of the Cutting Head needs to be adjusted:

- Loosen the locknut on the downward travel stop screw. (**Fig 14a**)
- Turn the adjusting screw (**Fig 14b**) out (counter-clockwise) to decrease the downwards travel of the Cutting Head.
- Turn the adjusting screw in (clockwise) to increase the downwards travel of the Cutting Head.
- Tighten the adjustment screw locknut when satisfactory downward travel of the Cutting Head is achieved.

#### ENVIRONMENTAL PROTECTION

Waste electrical products should not be disposed of with household waste. Please recycle where facilities exist.

Check with your Local Authority or retailer for recycling advice.



**EC DECLARATION OF CONFORMITY**



**The manufacturer of the product covered by this Declaration is:**

**UK:** Evolution Power Tools Ltd. Venture One, Longacre Close, Holbrook Industrial Estate, Sheffield, S20 3FR.

**FR:** Evolution Power Tools SAS. 61 Avenue Lafontaine, 33560, Carbon-Blanc, Bordeaux, France.

The manufacturer hereby declares that the machine as detailed in this declaration fulfils all the relevant provisions of the Machinery Directive and other appropriate directives as detailed below. The manufacture further declares that the machine as detailed in this declaration, where applicable, fulfils the relevant provisions of the Essential Health and Safety requirements.

**The Directives covered by this Declaration are as detailed below:**

<b>2006/42/EC.</b>	Machinery Directive.
<b>2014/30/EU.</b>	Electromagnetic Compatibility Directive.
<b>2011/65/EU &amp; 2015/863/EU</b>	The Restriction of the Use of certain Hazardous Substances in Electrical Equipment (RoHS) Directive.
<b>2002/96/EC as amended by 2003/108/EC.</b>	The Waste Electrical and Electronic Equipment (WEEE) Directive.

**And is in conformity with the applicable requirements of the following documents:**

**EN 62841-1: 2015 • EN 62841-3-10:2015/A11:2017 • EN ISO 12100: 2010 • EN 55014-1: 2017  
EN 55014-2: 2015 • EN 61000-3-11: 2000 • EN 50581:2012**

**Product Details**

Description: R355CPS 355mm (14") MULTI-MATERIAL CHOP SAW

Evolution Model No: R355CPS: UK 230V: 083-0001, UK 110V: 083-0002, EU 230V: 083-0003

Brand Name: EVOLUTION

Voltage: 110v, 220 - 240v ~ 50Hz

Input: 110v - 1800W, 220-240v - 2200W

The technical documentation required to demonstrate that the product meets the requirements of directive has been compiled and is available for inspection by the relevant enforcement authorities, and verifies that our technical file contains the documents listed above and that they are the correct standards for the product as detailed above.

**Name and address of technical documentation holder.**

Signed:  Print: Barry Bloomer - Supply Chain & Procurement Director  
Date: 14/06/2019

**UK:** Evolution Power Tools Ltd. Venture One, Longacre Close, Holbrook Industrial Estate, Sheffield, S20 3FR.

**FR:** Evolution Power Tools SAS. 61 Avenue Lafontaine, 33560, Carbon-Blanc, Bordeaux, France.

# evOLUTION®

evolutionpowertools.com

## AUS

Total Tools (Importing) Pty Ltd  
20 Thackray Road  
Port Melbourne  
Vic 3207

T: 03 9261 1900

## FR

Evolution Power Tools SAS  
61 Avenue Lafontaine  
33560, Carbon-Blanc  
Bordeaux

T: +33 (0)5 57 30 61 89

## UK

Evolution Power Tools Ltd  
Venture One, Longacre Close  
Holbrook Industrial Estate  
Sheffield, S20 3FR

T: +44 (0)114 251 1022

## USA

Evolution Power Tools LLC  
8363 Research Drive  
Davenport, IA  
52806

T: 1-833-MULTI SAW (TOLL FREE)

**DE** +44 (0)114 251 1022

**ES** +34 91 114 73 85

**NL** +44 (0)114 251 1022

**PL** +48 33 822 09 22

**PT** +34 91 114 73 85

**RO** +44 (0) 114 2050458

**RU** +33 (0)5 57 30 61 89

**TR** +90 (0) 312 9001810

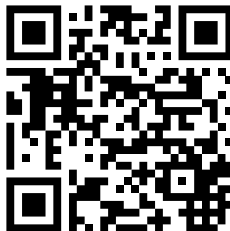

EPT QR CODE

V3 - BK1