

INSTRUCTION MANUAL

Original Instructions

12" Benchtop Wood Planer

ITEM # 22101

TABLE OF CONTENTS

General Safety Instructions	3
Specific Safety Instructions.....	4
Features	5
Power Supply	8
Plug and Grounding Requirements	9
Identifications.....	10
Controls and Components.....	11
Unpacking.....	12
Cleaning Up Your Machine.....	13
Assembly	14
Test Run	15
General Operation	16
Maintenance	20
Replacing or Adjusting Tension on V Belt	22
Planer Parts List.....	29

GENERAL SAFETY INSTRUCTIONS

Extreme caution should be used when operating all power tools. Know your power tool, be familiar with its operation, read through the owner's manual and practice safe usage procedures at all times

- ▶ **ALWAYS** read and understand the user manual before operating the machine.

CONNECT your machine **ONLY** to the matched and specific power source.

ALWAYS wear safety glasses respirators, hearing protection and safety shoes, when operating your machine.

DO NOT wear loose clothing or jewelry when operating your machine.

A SAFE ENVIRONMENT is important. Keep the area free of dust, dirt and other debris in the immediate vicinity of your machine.

BE ALERT! DO NOT use prescription or other drugs that may affect your ability or judgment to safely use your machine.

DISCONNECT the power source when changing drill bits, hollow chisels,

router bits, shaper heads, blades, knives or making other adjustments or repairs.

NEVER leave a tool unattended while it is in operation.

NEVER reach over the table when the tool is in operation.

ALWAYS keep blades, knives and bits sharpened and properly aligned.

ALL OPERATIONS MUST BE performed with the guards in place to ensure safety.

▶ **ALWAYS** use push sticks and feather boards to safely feed your work through the machine.

ALWAYS make sure that any tools used for adjustments are removed before operating the machine.

▶ **ALWAYS** keep the bystanders safely away while the machine is in operation.

WARNING!

The safety instructions given above can not be complete because the environment in every shop is different. Always consider safety first as it applies to your individual working conditions.

THICKNESS PLANER SPECIFIC SAFETY INSTRUCTION

If you are not familiar with the operation of a thickness planer, you should obtain the advice and/or instruction from a qualified professional.

Never reach into or through the throat of the thickness planer. Even with the power turned off, the cutter-knives are very sharp.

Keep the cutter head and knives clean and free of tar and pitch.

Be sure that the motor switch is properly grounded.

Check each and every board to be surfaced for loose knots, nails, screws and any other foreign materials and defects before planing.

Keep hands away from the surface of the wood as it nears the in-feed rollers.

Make all adjustments with the power OFF.

Always keep the machine clean and free of sawdust and wood chips. They may contain moisture that could cause the cast-iron surfaces to rust.

Turn Off the power before removing any wood shavings and sawdust from the surface of in-feed & out-feed tables.

THINK SAFETY. WORK SAFELY

IMPORTANT!

The safety instructions given above cannot be complete because the environment in every shop is different. Always consider safety first as it applies to your individual working conditions.

**22101- 12”
BENCHTOP PLANER
WITH DUST COLLECTION**

BENCHTOP PLANER WITH DUST COLLECTION

As part of the growing line of Chansen woodworking equipment, we are proud to offer the 22101 12” Benchtop Planer to our line of reliable quality machinery. By following the instructions and procedures laid out in this user manual, you will receive years of excellent service and satisfaction from your us. The 22101 is professional grade tool and like all power tools, proper care and safety procedures should be adhered for longevity of service from the machine as weel as provent personal injury.

MOTOR SPECIFICATIONS:

Type: Universal Motor with Brushes

Horsepower:2HP

Amps: 15A

Speed: 17,500RPM

Power Transfer: Belt Drive

Bearings: Shielded & Permanently Lubricated

ELECTRICAL SPECIFICATIONS:

Hydro Requirement:220V Single Phase

Prewired Voltage: 220V

Full Load Current: 15A

Minimum Circuit Size:20A

Connection Type:6ft Cord and Plug

Power Cord Gauge:14AWG

Switch Type: Paddle Switch with Yellow Removable Safety Key

MAIN SPECIFICATIONS:

Maximum Planning Width:..... 12”
Minimum Stock Thickness:..... 5/16”
Maximum Stock Thickness:..... 4-1/2”
CutterHead Speed:..... 8750RPM
Cuts Per Inch:..... 60
Cuts Per Minute:..... 17,500
Planner Feed Rate:..... 26FPM
Maximum Cut Depth Planning full width:..... 1/16”
Maximum Cut Depth Planning 6” Wide Board:..... 1/8”

CUTTERHEAD INFORMATION:

CutterHead Type:..... 2 Knife
Cutterhead Diameter:..... 2”
Knife Type:HSS (Reversible)
Knife Length:..... 12-1/2”
Knife Width:..... 1/2”
Knife Thickness: 1/16”

TABLE INFORMATION:

Table Surface Length:..... 12-3/4”
Table Surface Width:..... 12-1/2”
Table Surface Thickness:..... 3-5/8”
Roller Extension Length:..... 6-1/4”
Roller Extension Width:..... 13”

MACHINE CONSTRUCTION:

Table:..... Stainless Steel
Body:..... Aluminum
Cutterhead Assembly:..... Steel
Infeed and Outfeed Roller:..... Rubber and Steel
Paint Finish:..... Powder Coat
Measurement Scale:..... Metric and Imperial
Dust Ports:..... 2-3/8”(x1)

OTHER SPECIFICATIONS

Country of Origin:..... China
Warranty:..... 1 year
Serial Number Location:..... ID Plate
Sound Rating:..... 95dB
ISO 9001 Factory:..... Yes
Certified By a Nationally Recognized Laboratory (NRTL):..... Yes (CETL)

POWER SUPPLY

AVAILABILITY OF POWER

Before Installation of this machine you will need to consider the proximity of your power supply circuit. If available circuits do not meet the requirements for this machine you will have to get a new circuit installed by a licensed electrician. Use of a licensed electrician will minimize the risks of fire, electrocution, damage to equipment, and will insure everything is wired in accordance to the applicable codes and standards.



FULL LOAD CURRENT RATING

This is the amount of Amps a machine draws under 100% of the rated output power.

FULL LOAD RATING FOR 220V 15AMPS

The full load current is not the maximum amount of amps the machine will draw. The machine has potential to draw current beyond the full load rating if it is overloaded. Overloading of the machine for an extended period of time can cause damage, overheating, or even fire. The risk is higher if the machine is on an undersized circuit. To help avoid these issues insure you are connected to a circuit in which meets the specified circuit requirements for this piece of machinery.

WARNING!

Do not connect machine to power before setup has been fully completed to avoid risk of personal injury or property damage.

CIRCUIT REQUIREMENTS

The 22101 has been prewired at the factory for operation on an electrical circuit that has a verified ground and meets the below requirements:

Voltage: 220V
Cycle: 50/60Hertz
Phase: Single
Circuit Breaker Size: 20Amps

Please Note:

1. An electrical circuit includes all electrical equipment between the breaker panel and the machine. This is why it is important to have the proper circuit size so it can safely accommodate this machine under full load for an extended period of time.
2. The circuit requirements laid out in this manual are for a dedicated circuit in which only one machine will be operational or installed at a time.
3. If you choose to connect to a shared circuit where more than one machine may be running at a time please consult with a qualified electrician to insure the circuit is properly sized for safe operation.

PLUG AND GROUNDING REQUIREMENTS

This machine must be grounded so that in the event of certain malfunctions it will reduce the chances of electrical shock by providing a path of lesser resistance for the electric current to travel through. For this reason the machine comes with a cord equipped with an equipment grounding wire that leads in to the grounding prong on the plug.

NOTE

The three prong plug is only to be plugged in to the matching receptacle that is properly installed according to the local electrical codes and standards. Under no circumstances should you modify the plug to make it fit in a receptacle that is not meant for this configuration. (see figure 1)

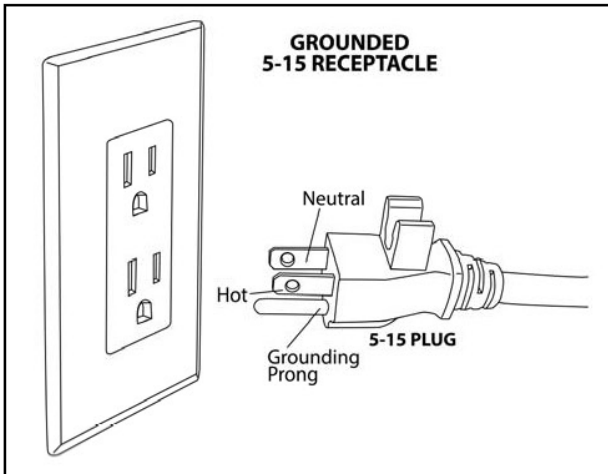

Figure 1

If there is an improper connection of a machine grounding wire it may result in a heightened risk of electric shock. If repair or

replacement of the power cord is necessary in the future please consult a licensed electrician.

NOTE

If ever you notice damage or wear to either the cord or plug disconnect it immediately from the power supply and have it replaced by a licensed electrician or service tech before any further use of the machine.

USE WITH EXTENSION CORDS

If you absolutely must require the use of an extension cord with your machine do so, on a temporary short term basis only.

NOTE

1. We recommend that you do not use an extension cord with this machine. Also the longer the extension cord the greater the possibility of voltage drop causing the motor to work harder under powered which in turn will cause it to draw more amps. This may cause the thermal overload to trip or even the breaker in your electrical panel. It may also cause the extension cord to heat up which can be a potential fire hazard.

2. If an extension cord is used with this machine it must have a ground wire with a plug that matches the one currently installed on your machine. The extension cord must also meet the following specifications below:

Minimum Wire Gauge: 12 AWG
Maximum Cord Length: 50 ft.

Identification

Review this diagram of this 22101 to help yourself become familiar with the names and locations of the controls and features labeled below. To help better understand, make sure to read the instructions.

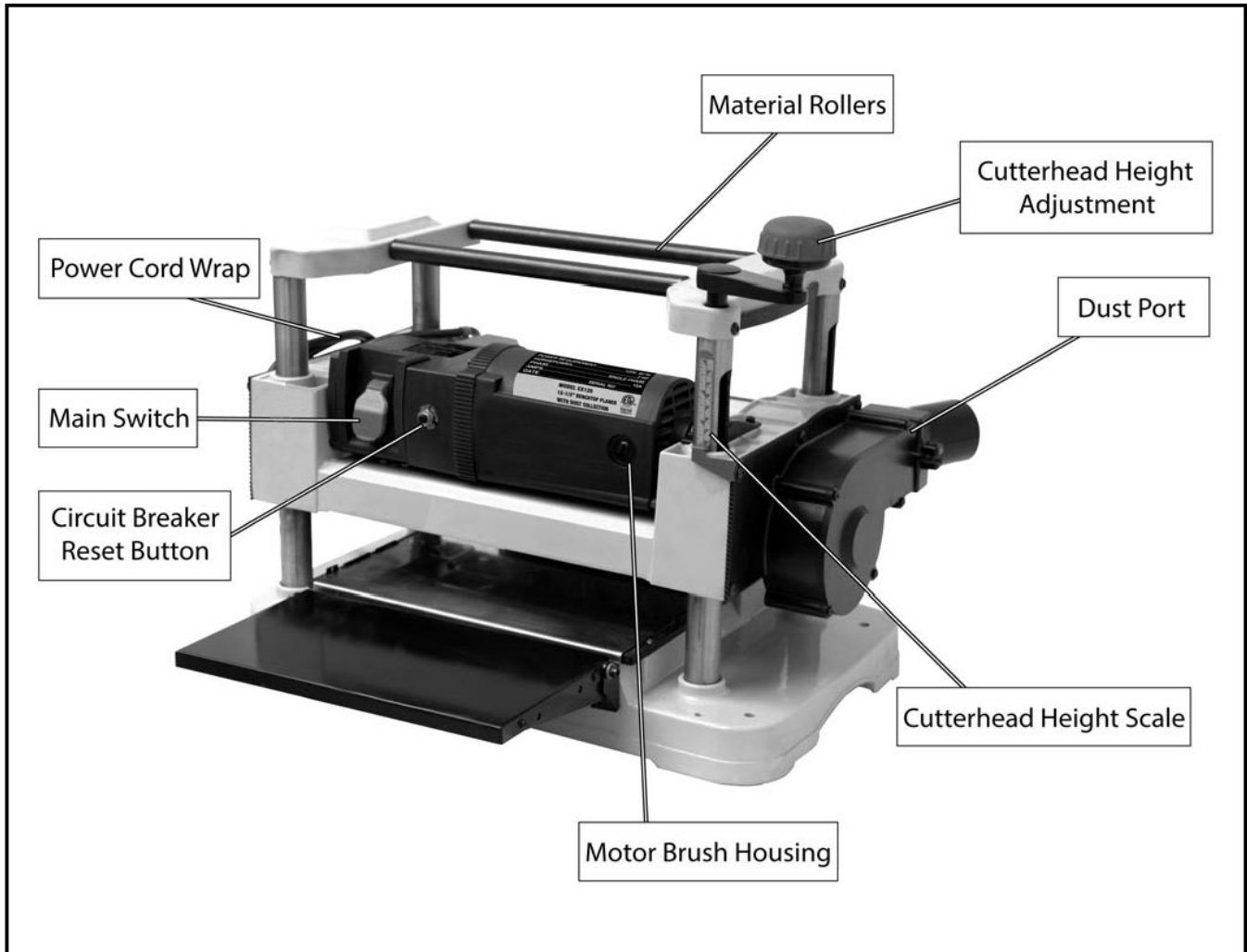

Model CX125 controls and components

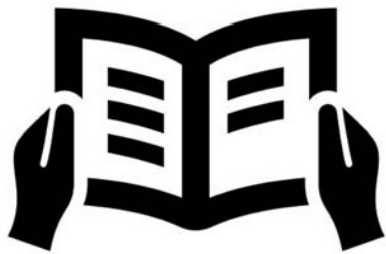
	<p>WARNING! To reduce the risk of injury, make sure to read all of the manual, BEFORE operating machine.</p>
---	--

Controls and Components

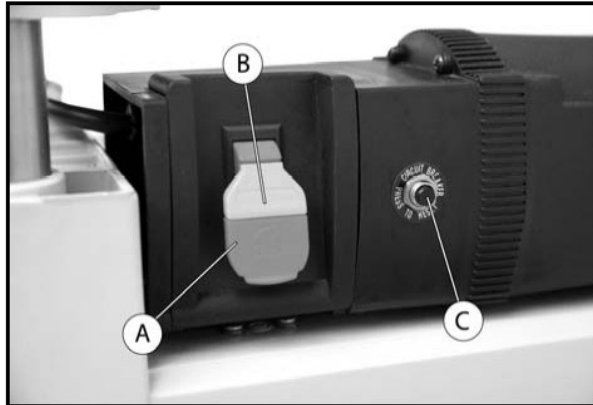
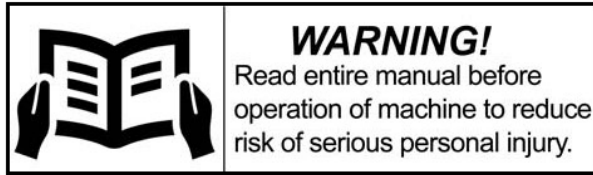

Figure 2. ON/OFF switch and reset button

- A. Main Switch:** Turns the motor on when in the up position; turns motor off when in the down position.
- B. Main Switch Safety Key:** Disables switch when yellow key is removed so the motor is unable to start.
- C. Reset Button:** Allows the machine to be restarted in the event the thermal overload protection has tripped on the motor. To reset the button make sure the main switch is in the off position. Wait 5 minutes to allow the motor to cool down. Then you may press the reset button. If reset button does not stay depressed the motor will require more time to allow for cooling. Then try pressing the reset button again.

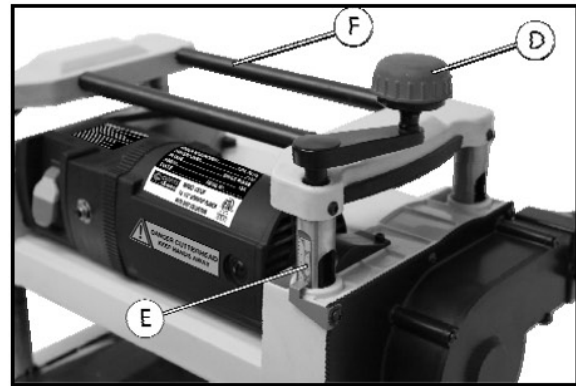

Figure 3. Elevation controls and return rollers.

- D. Cutterhead Adjustment Crank:** Raises and lowers the cutterhead. Turn the adjustment crank clockwise in order to raise the cutterhead or turn the adjustment crank counterclockwise in order to lower the cutterhead.
- E. Cutterhead Height Scale:** The red arrow shows the height of the cutterhead in relation to the table. The measurement indicated by the arrow is the thickness of the board after planing.
- F. Return Rollers:** Located atop of the 22101 for assistance in sliding the workpiece back to the operator.

UNPACKING

This machine has been carefully packed in order to protect it during transport. While unpacking thoroughly go through the box and separate all items from the materials used for packaging. It is always wise to inspect all items for shipping damage.

NOTE

Please keep all material used in packaging until you are satisfied with your machine and have rectified any issues between Busy Bee Tools or the agent of shipping. (Ex: Shipping damage claim)



WARNING!

Immediately remove and keep all plastic bags and packaging away from pets and children. Put directly into trash or recycling.

ITEMS

Qty

A. Dust Bag (Optional):	1
B. Dust Port 2-3/8 (Optional):	1
C. Dust Bag Clamp:	1
D. Power Cord wraps:	2
E. Cutterhead Adjustment Crank	
Arm:	1
F. Cutterhead Adjustment Crank	
Handle:	1
G. Hex Wrench 4mm:	1
H. Knife Change magnets:	2
I. Other Hardware (not pictured)	
Flat washer 5mm:	1
M5-.8 x 25 button Head	
Cap Screw:	1
M5-.7 x 10 Phillips	
Head Screw:	4

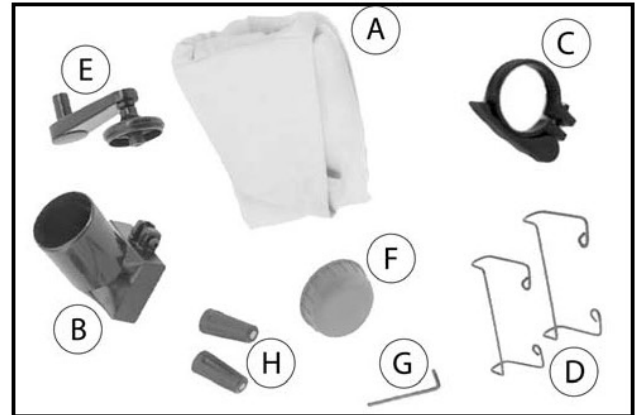

INVENTORY LIST

The following is an itemized list of the items that come with your new machine. Before you begin following the procedures for setup of the machine lay out everything and check that it matches the inventory list.

NOTICE

If an item appears to be missing from items inventory list carefully go through packaging materials and inside of the machine as they may have been pre-installed at the factory or misplaced during unpackaging.

CLEANING UP YOUR MACHINE

Your machine has unpainted surfaces that have been covered with a heavy coat of packing grease and rust preventatives to prevent any corrosion during storage or shipment of this machine. Although the grease and rust preventatives work well you will need to be patient and clean it off the unpainted surfaces. This process will take a little time.

There are multiple methods that can be utilized for this process however we recommend the following steps:

NOTE

We do recommend that this process is done in a well-ventilated place to minimize any exposure to toxic fumes that may be harmful to your health.

CLEANING ESSENTIALS

Degreaser (WD40 Specialist Machine & Engine Degreaser Foaming Spray or even regular WD40)

Plastic Scrapper (a metal scrapper may damage or mar the surface you are degreasing)

Eye protection

Rubber Gloves

Rags

RUST PREVENTATIVE REMOVAL STEPS

1. Make sure that you are setup for rust preventative removal in a well ventilated area.

2. Put on all required safety equipment. (Eye protection and rubber gloves).
3. Spray surface with a generous amount of the degreasing agent and let it soak in and break down the grease for 10 minutes. This will allow the degreaser time to work.
4. Now you can wipe the excess degreaser off of the surface. If your degreaser was effective the rust preventative should have started to breakdown and come off. Try using the plastic scrapper to remove most of the preventative. After scrapping wipe down the surface again.

NOTE

You may need to repeat steps 3 and 4 until all the rust preventative is able to be removed leaving a clean surface.

ASSEMBLY

This section will cover the installation steps required for the crank arm, crank handle, dust collection ports, and the power cord wraps. These items must all be installed correctly before operation of the 22101 planer. Follow the steps below:

1. Assemble the cutterhead height adjustment crank by snapping the crank handle on to the crank arm.
2. Remove the black plastic cover from the crank arm.
3. Line up the flat spot in the crank arm with the flat spot on the height adjustment shaft. Then press it into place.
4. Now that the crank arm is in place thread the M5 .8 x 25 button head screw and 5mm washer into the shaft through the crank arm. Tighten with the supplied 4mm hex wrench. Be careful not to over tighten as you may strip the thread with the use of too much force.
5. Put the black plastic cover back on the crank arm to cover the M5 .8 x 25 button head screw.



6. Place both of the supplied power cord wraps over the pre drilled holes on the side of the planer machine housing using the four M4-.7 x 10 phillips head screw.

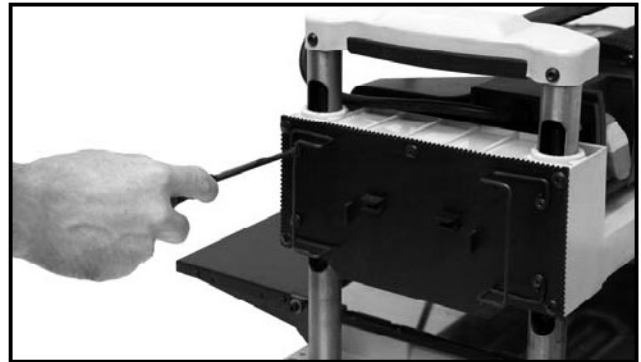

7. Place the dust collection port onto the fan housing on the side of the planer opposite the power cord wraps. It should slide into place then tighten the pre-installed button head screw with the supplied 4mm hex wrench.

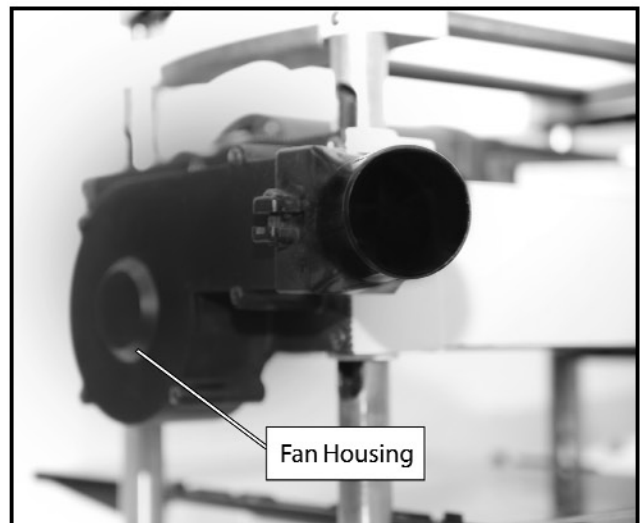

- Place the dust bag into the supplied hose clamp (with bag). Slide the open end of the dust bag over the dust port and secure it in place by locking the hose clamp handle in to place.

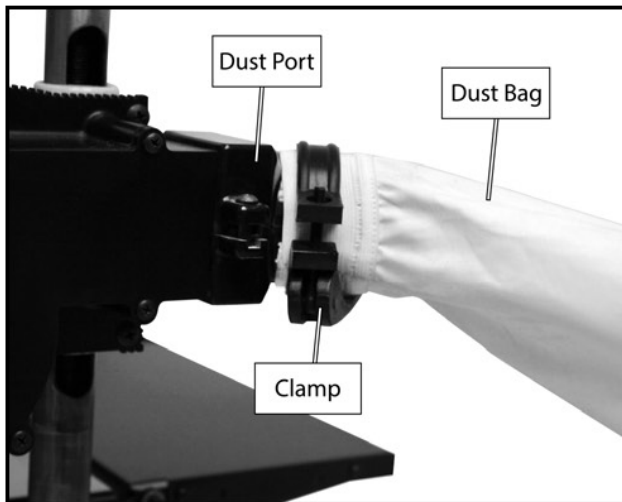

	<p>CAUTION! Breathing in airborne dust on a regular basis may result in permanent respiratory illness. Reduce your risk by using a dust collection system and wearing a respirator while using this machine.</p>
--	---

OPTIONAL: HOOK UP TO DUST COLLECTOR

- Remove the existing dust bag and hose clamp from the 2-3/8" dust collection port.
- Slide a 2-1/2" piece of hose on the dust port and fasten it in place using the appropriate hose clamp.
- Make sure that the hose is secured tightly and the seal between the hose and dust port is air tight in order to prevent loss of suction and ensure proper performance.

TEST RUN

Now that you have completed the assembly of your machine it is time for the test run. The test run is to confirm that everything is functioning as it should.

NOTE

If you do happen to encounter any unusual issues or problems stop the machine immediately and disconnect it from the power supply. The issues must be fixed before operation of the machine. The trouble shooting section is located in the service and maintenance part of the manual it may be of help.

The test run is used to confirm the following:

- That the motor energizes and runs properly.
- That the main switch with the safety key function as intended.

WARNING!

Make sure you read and understand the manual and are aware of all controls and safety features before operation of machine to reduce risks of serious injury or death.

WARNING!

Machine is not to be started or operated before setup instructions have been performed according to the manual. Operation of a machine that is improperly set up can lead to serious injury, death or machine damage.

HOW TO TEST RUN THE MACHINE

1. Please make sure that you have read and understand all safety instructions located at the start of the manual.
2. Make sure that the machine was set up properly in accordance with the instruction manual.
3. Clear the area of all tools and objects used in the assembly stage as well as any other items that may be in the area.
4. Plug the machine in to the power source.
5. Turn the main switch on to confirm that motor is operational and then turn the machine off. Motor should run smoothly without any unusual noises or issues.
6. Remove the yellow safety key from the centre of the main switch.



7. Now that the safety key has been removed from the main switch try and start the machine. If the machine does not start the safety key feature is working as intended.

GENERAL OPERATION

This is a general overview to help the beginner machine operator develop a basic understanding of how the machine is to be used during operation. This will help make the controls and components discussed later in this manual easier to understand.

NOTE

This should only be considered as a general overview and it is not intended to be an instructional guide. For more in depth learning on specific operations please seek additional training.

To complete a basic operation, the operator will do the following:

1. Put on all required safety equipment like safety glasses, ear plugs, and respirator.
2. Check material to make sure that it's suitable for planing.
3. If the material is bowed you will have to surface plane one side of the material on a jointer to ensure that it rests flat and solidly on the planer table during operation.
4. Place your material on the table with the flattest side down. Place the front edge of your material far enough beneath the cutterhead to set the depth of cut using the cutterhead height scale.

5. Correctly set the cutterhead height to the material thickness by turning the height adjustment crank either clockwise or counterclockwise depending on thickness of material.
6. Once you have all your personal protective equipment on and all safety precautions have been taken you can now turn on the planer.
7. Stand by the side of the planer to give the material a clear path and to reduce the risks of kickback and injuries. Place flat surface of the material down and slowly feed the material in to the planer until the infeed rollers grab it.
8. Once the material has passed through and is clear of the outfeed roller, measure the material thickness and if further planing is required just lower the cutterhead using the height adjustment crank. Continue these steps until required thickness is reached.
9. When finished planing turn machine off using the main switch.

MATERIAL INSPECTION

Not all work materials are suitable for use and may need modification before being able to be planed. Before planing check all material for the following:

Foreign Objects: Look for defects in the material and things like nails, staples, imbedded gravel, and other impurities.

Wet Stock: Do not plane wood that has higher moisture content than 20% like wood that has been exposed to rain or snow as it is hard on the machine and will cut poorly and could cause excessive wear to the machine as well. Too much exposure to moisture may cause rust and corrosion of your machine and related components.

Material Containing Knots: Knots when loose run the risk of dislodging and coming out during the planing process causing kickbacks, damage to the machine or even injury.

Material Type: Only natural wood material is meant for use with this machine. Use of any other materials like plywood may cause machine damage or even serious injury.

Warping: Materials with excessive warping should not be used for planing because they can be unstable as well as unpredictable when making contact with the cutterhead causing possible machine damage or even resulting in personal injury.

COMMON PROBLEMS AND SOLUTIONS

Snipe: This typically happens when the ends of the board have more material removed from the surface than the middle. This can be caused by the board not properly being supported as it passes through the cutterhead. Small amounts of snipe are common and expected.

Remedy: The easiest way to deal with this issue is to plane a board longer than required and remove the ends of the board when finished planing.

Fuzzy Grain: This issue may be caused by planing materials with too high of moisture content. In some cases fuzzy grain is hard to avoid given the natural characteristics of wood such as bass wood or may even be the product of dull knives.

Remedy: It is always wise to check your materials with a moisture meter to determine whether or not it is suitable for planing. If the moisture content is above 20% the material will require more drying

time or try using kiln dried materials. However if moisture is not the issue then check the knives to ensure that they are sharp and not dull.

Chipped Grain: This is typically occurs with materials containing impurities or when cutting against the grain. Chipped grain may also be caused by dull or damaged knives (chipped blades).

Remedy: To prevent issues such as chipped grain try removing less material per pass by adjusting the cutterhead height. If material doesn't have a heavy concentration of cross grain you may want to check and inspect the cutterhead knives.

Chip Marks and Indentations: This is typically caused by too much material being removed making for larger wood chips that are unable to be cleared through dust collection port. Because of the debris staying in the machine it gets re-deposited on to the workpiece and firmly pressed into it by the outfeed rollers resulting in indentation or marking. This again may also be caused by knives that are too dull or damaged and cutting poorly.

Remedy: To help eliminate this issue ensure that the cutterhead knives are sharp and not dull or damaged. Also try removing less material at a time by reducing the depth of cut and only using wood suitable for planing with moisture content less than 20%.

CHANGIG DEPTH OF CUT

The depth of cut when planing is adjusted by the cutterhead adjustment crank located on top of the jointer. To raise the height of the cutterhead turn the crank clockwise and to lower it counterclockwise.

The cutterhead height adjustment crank is a simple yet accurate way for obtaining consistent cut depths on multiple passes.

The height adjustments lead screw has a screw pitch of 16 threads per inch. This means that every full rotation of the height adjustment crank will move the cutterhead 1/16" up or down and every quarter turn would move the cutterhead 1/64".

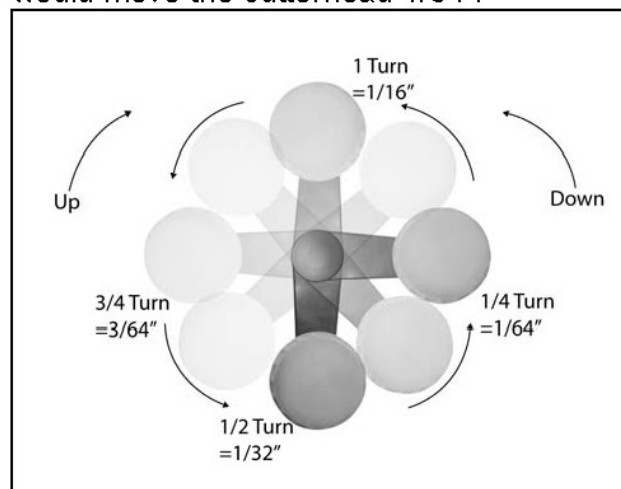

Anytime you switch from raising the cutterhead to lowering the cutterhead you may experience slight amount of backlash. Backlash occurs during the first turn of the height adjustment crank in the opposite direction from which you were previously working so the first rotation of the crank will not be exactly 1/16" of movement up or down for the cutterhead. Backlash will not be experienced when moving the cutterhead in the same direction as you are currently working.

NOTE

Maximum depth of cut may vary dependent on the type of wood, hardness, and width of material being planed. For best results we recommend you remove no more than 1/32" at a time for cleaner cuts and less stress on the machine.

HEIGHT ADJUSTMENT SCALE

The cutterhead height relates directly to the scale located at the front of the planer. The measurement indicated by the red arrow on the scale will be the thickness of the board after planing. However the cutterhead height adjustment scale is not a precise measurement but an approximation.

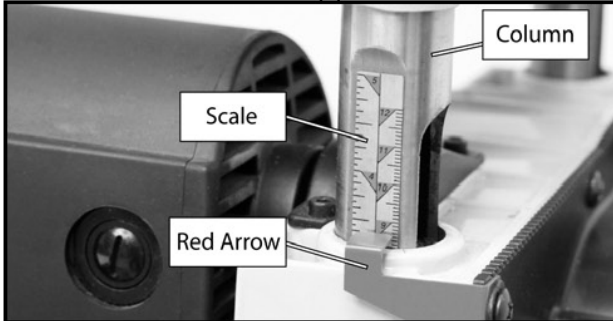

FEEDING MATERIALS

The rate of feed is preset on this machine at a rate of 26 FPM (Feet Per Minute). The purpose of the infeed and outfeed rollers are to keep the pressure on the material as it passes under the cutterhead keeping it flat and moving at a consistent 26 FPM.

How to Feed Material:

1. Rest the material on the table surface of planer with the side to be planed facing up towards the cutterhead. Material over 2 feet should be supported at both sides of the planer.
2. Lower the cutterhead by turning the cutterhead height adjustment crank until the depth bar barely touches the surface of material to be planed.

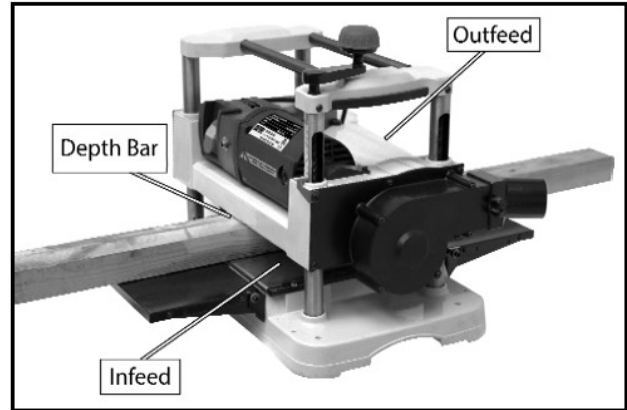

3. To remove the recommended $1/32$ " depth of cut turn the height adjustment crank $1/2$ turn clockwise.
4. Turn the planer on and with the flat side of your material facing down slowly feed it through the planer well standing beside the material to reduce possibility of kickback injuries.
5. Once the material has cleared the outfeed roller check material thickness. If material requires more planing turn the height adjustment crank a half turn before putting material back through again to remove another $1/32$ ". Continue to repeat this step until you have reached your target thickness.

MACHINE MAINTENANCE

NOTE

Before any maintenance is to be performed you **MUST unplug machine from the power supply** to prevent any accidental startups and risk of electrical shock.

Maintenance

In order to ensure optimal performance from your machine please follow the following maintenance steps:

You should check things like damaged knives, If the mounting bolts are loose, and look for worn or damaged wires daily before operation of machine.

Once a month you should remove any dust or debris from chains and sprockets. Then lightly coat the chains and sprockets with bearing grease.

Check the V belt tension once a month also inspect for damage or wear on the belt.

Once a month while the machine is disconnected from the power source remove the cutterhead guard and fan cover to remove all dust and debris that have built up from regular use of the machine.

LUBRICATION

Always clean all dust and debris from roller chain drive, table height chain drive, and the lead screw for the cutterhead height adjustment before applying any kind of lubricant.

To Lubricate Height Adjustment Lead Screw:

1. Always disconnect machine from power source.
2. Clean all parts thoroughly until they are clear of any dust and debris using mineral oils

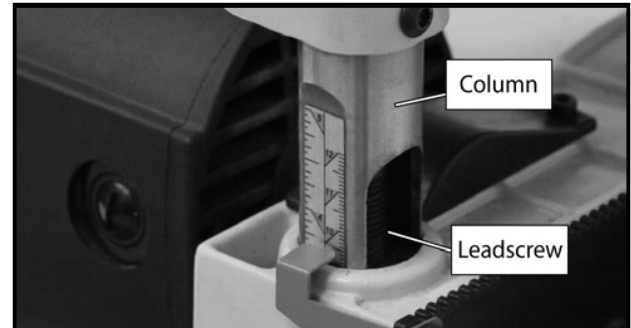

3. Apply lubricant onto all four lead screws then use the cutterhead height adjustment crank to move the cutterhead up and down to help distribute the lubricant evenly.

To Lubricate Table Height Chain/Feed Roller Drive Chain:

1. Always make sure the machine is disconnected from the power supply.
2. Carefully rest the planer on its side to gain access to the table height chain.

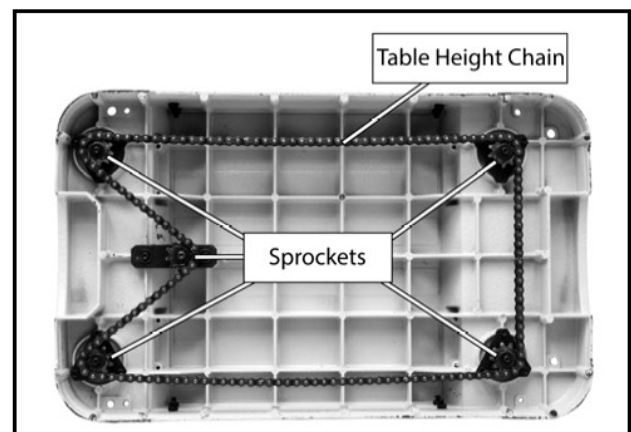

3. Remove all dust and built up debris using mineral spirits before applying grease to chain and sprockets.
4. Restore machine back to its upright position.
5. Remove side cover to expose the feed roller drive chain then repeat steps 3 and 4.
6. Re install side cover when finished lubricating drive chain and sprockets.

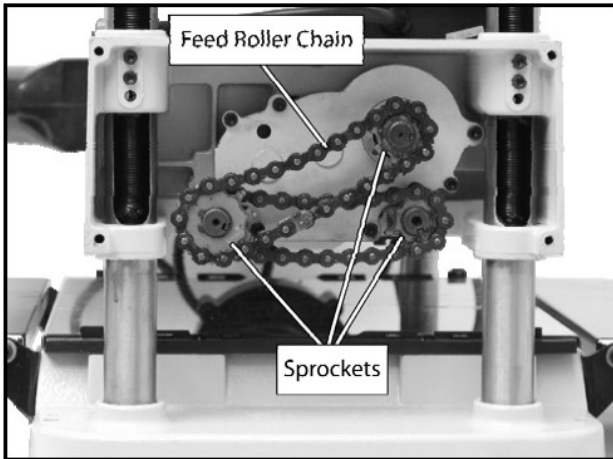

Knife Replacement Procedure

NOTE

Cutterhead knives are extremely sharp. Accidental contact with them can result in severe injury. Please exercise extra caution when changing or working around the cutterhead.

When reversing or changing the knives they should be done both at the same time to keep them a matching set and maintain accurate and consistent planing. The knives may need to be replaced when you notice things like:

Fuzzy appearance on surface of wood after planing because the

wood fibers are being torn instead of cut cleanly.

Lines or ridges in material after planing caused by chipped blades

Raised Grain after planing from dull knives hammering the board surface.

How to Remove Knives

1. Make sure that machine is disconnected from the power supply.
2. Remove cutterhead guard by undoing the (2) M5-.8x10 screws. Once screws have been removed the guard should lift off.

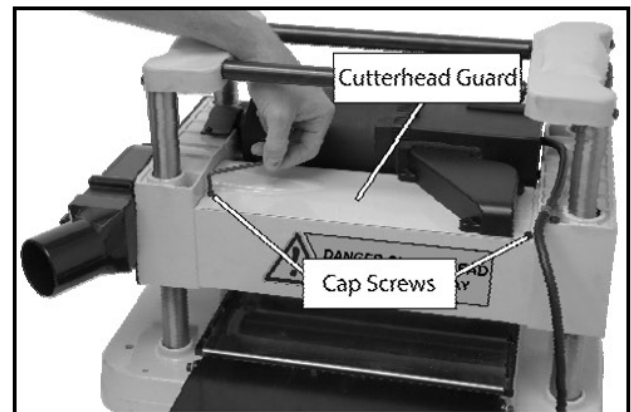

3. Carefully wearing thick work gloves (heavy leather) rotate the cutterhead until knives become visible.



4. Undo and remove the (6) M6-1x16 cap screws using the supplied 4mm hex wrench from the gib.
5. Once screws are removed from the gib remove the gib using supplied magnets then remove the knives.

Inspecting Cutterhead Assembly

1. Make sure machine has been disconnected from the power supply.
2. Clean the cutterhead carefully with a shop rag. Once clean check for the following with a flashlight for better visibility.

Check for buildup of glue or resin on the cutterhead, gib, and knives. Remove all glue and resin so the knives and gib will sit flat on the cutterhead.

Check knives for any cracks, chips, or damage. If one knife is damaged you should replace both as a set.

Check and make sure that the threaded screw holes contain no sawdust or debris.

Check and make sure the hex sockets and screw heads are all in good condition. Replace any that may appear worn.

Replacing Knives

1. Make sure the machine has been disconnected from its power source.
2. Using the supplied magnets to position the knife over the two pins on the cutterhead. Make sure that the orientation of the knife is such that the beveled edge is up.

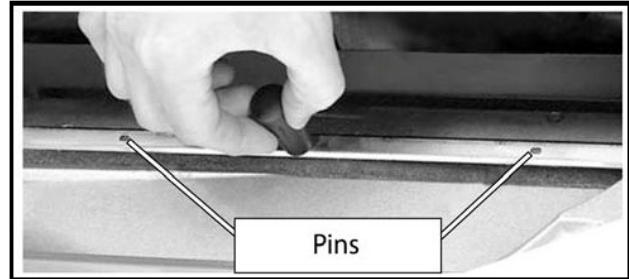

3. Again using the supplied magnets place gib over the knife. Fasten the gib securely using the (6) M6-1x16 cap screws.

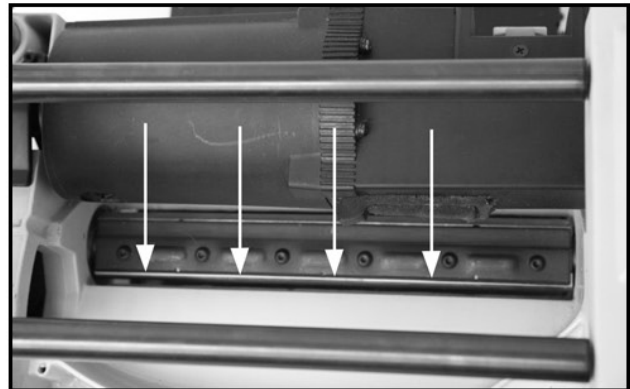

4. Rotate the cutterhead carefully until the other knife slot is visible and then repeat steps 2 and 3. Finally replace the knife guard when finished.

Replacing or Adjusting Tension on V Belt

The cutterhead assembly is driven by a belt that is located on the right side of the planer. Over time even though the belt is strong and durable it may begin to stretch and slip signaling a need to be adjusted or even replaced.

1. Make sure that the machine has been disconnected from its power supply.
2. Remove dust port and fan housing from the machine by undoing and removing the (5) M5-.8x15 tap screws.

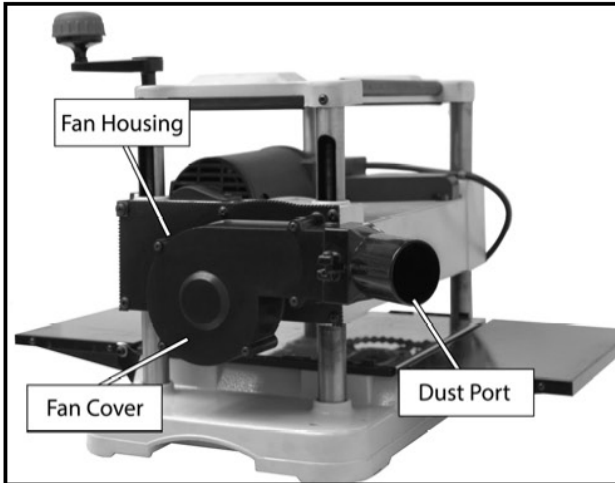

3. Remove the fan that is connected to the shaft by undoing the M6-1x12 button head cap screw (note that it is left-hand thread) fan should slide off shaft.
4. Remove housing to expose the V belt by removing the (5) M6-1x12 phillips head screws .
5. Remove the belt gaurd by undoing the (2) M5-8X10 cap screws.

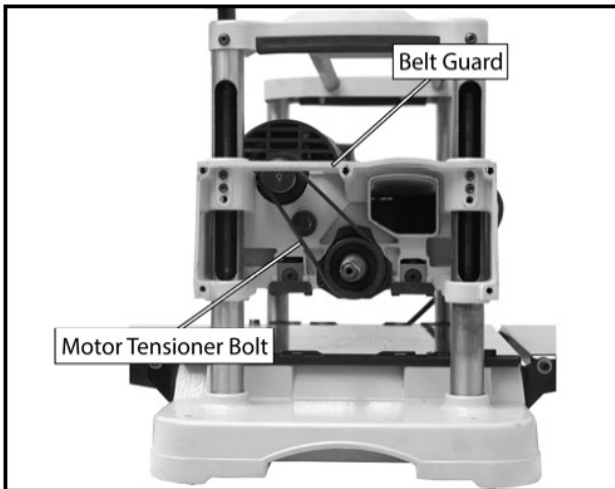

6. Release the tension on the V belt by loosening the motor tensioning bolt. Once tension is released remove the V belt by rolling it off the motor pulley.

7. Place the new V belt over both pulleys. To tension the belt rotate the motor towards front of the planer using medium force. Hold V belt in place while tightening the motor tensioning bolt. Belt deflection should be around 3/8" when pressure is applied on belt at the centre point between the two pulleys.

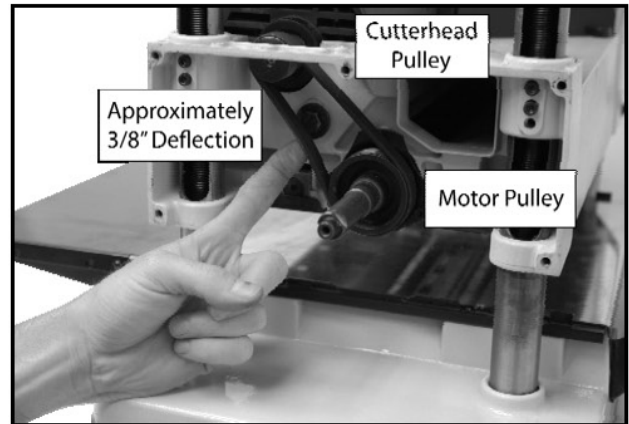

8. Reinstall the belt gaurd fan housing, fan, and fan cover in the opposite order that they were removed.

Changing Motor Brushes

The motor has two carbon brushes. The life expectancy of the carbon brushes is directly affected by regularly planing wide boards, planing dense wood, and cutting too deeply will shorten the life of your brushes.

Inspect the carbon brushes should the motor loose power, become noisy, or is failing to reach full power. New brushes measure 5/8" long so if brushes measure less then 1/4" they will need replacing.

1. Make sure that the machine has been disconnected from its power supply.
2. Unscrew the brush cap located on the front of the motor. Remove the carbon brush carefully from the motor.

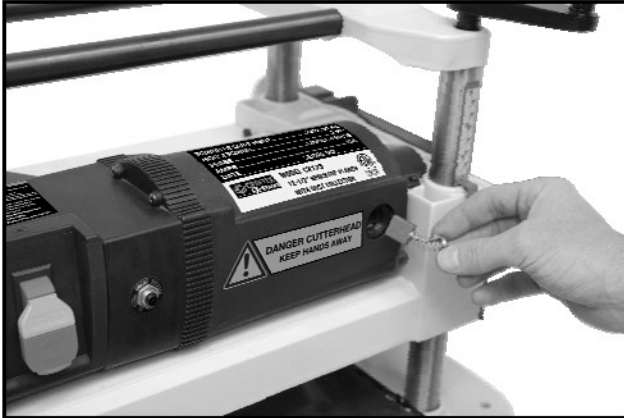

3. Install the new carbon brush and screw the brush cap securely back in place. Repeat steps 2 and 3 when changing brush on other side of the motor.

Infeed/Outfeed Rollers Cleaning

The infeed/outfeed rollers rotate inside spring loaded bushing blocks. The rollers push upwards on the board so that the roller pressure is maintained. If debris like wood chips and sawdust buildup between the bracket and bushing block the amount of vertical roller travel will be limited causing incorrect feeding of material through the planer.

1. Make sure that the machine is disconnected from its power supply.
2. Take a 4" tall wooden block and place it between one feed roller and the planer table. Make sure wooden block isn't resting directly under the cutterhead.
3. Lower the cutterhead just enough so that the rollers are pushed up against the spring and pressure is off both of the brackets.
4. Remove any trapped debris like wood chips and sawdust from between the roller assembly and bracket.

Scale Calibration

Even though the scale is set correctly at the factory it can be adjusted for accuracy if it becomes necessary. Follow these steps to make any adjustments:

1. Take a piece of scrap wood and plane both sides until flat and even thickness for the length of the material.
2. Measure the thickness of the material using calipers.
3. If there is a difference in measurement between the calipers and the scale loosen the M6-1x12 phillips head screw on the red arrow. Then reposition the arrow to indicate the correct thickness and retighten the screw.

Table Height Adjustment

Both the table and the cutterhead are checked at the factory to ensure that they are parallel. However over long periods of time and extended use it may change. To return the table and cutterhead back to the point of being parallel follow the steps below:

1. Plane a test piece of material and measure the thickness from side to side and front to back. From those measurements determine the corners that are in need of adjustment.
2. Make sure that machine has been disconnected from its power supply.
3. Carefully tilt and gently lay the machine on its side to gain access to chain and sprockets.

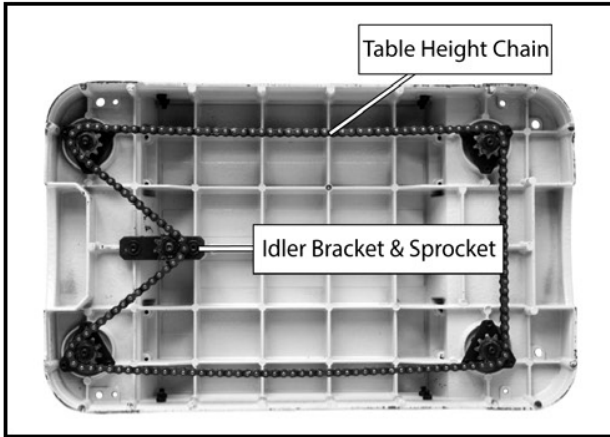

NOTE

It is important that the chain does not fall off the sprockets as it can be very difficult to return chain to proper location on sprockets without having to change table adjustments.

- Loosen the (2) M5-.8x10 cap screws on the idler bracket to loosen chain. Do not remove chain.

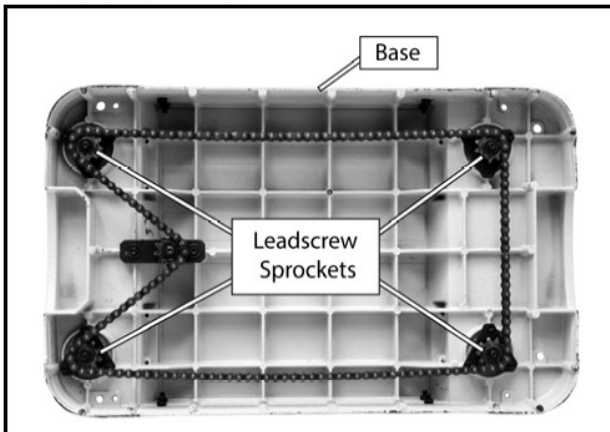

- Carefully lift the chain clear of one lead screw sprocket at a time. Rotating the sprocket by one tooth will raise or lower that corner by approximately 0.006" depending on direction of sprocket rotation.
- When done the adjustments retighten the idler bracket with cap screws.
- Return the machine to its proper upright position.

- Make a test cut with a piece of scrap wood to verify that the table and cutterhead are now parallel. If not parallel re-do steps 3 to 7 again.

Wiring Diagram & Electrical Components



Figure for Paddle switch



Figure for Circuit breaker

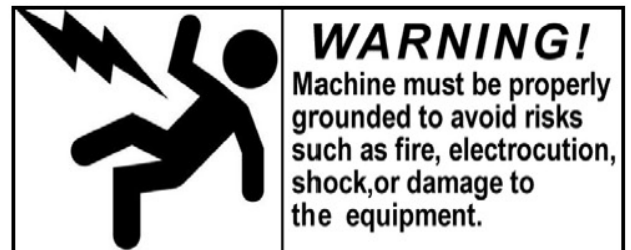

WARNING!

Machine must be properly grounded to avoid risks such as fire, electrocution, shock, or damage to the equipment.

NOTICE

The motor wiring shown below was current at time of manual production, however it may not be the same. Always refer to the diagram inside motor junction box.

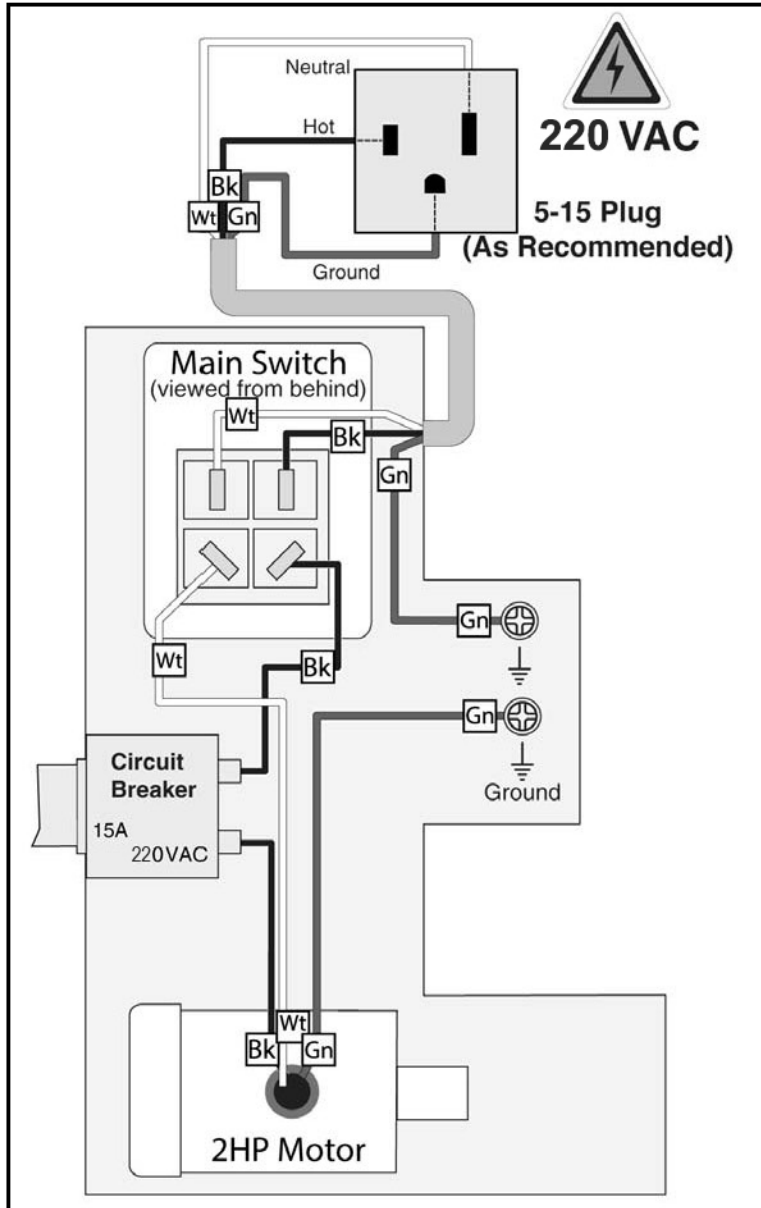

TROUBLE SHOOTING

PROBLEM	POSSIBLE CAUSE	POSSIBLE SOLUTION
Motor will not start or run	<ul style="list-style-type: none"> A. Main switch yellow safety key removed B. No power to machine C. Motor circuit breaker may have tripped D. Malfunctioning switch or loose wire E. Carbon Brushes are at fault 	<ul style="list-style-type: none"> A. Re install yellow safety key in centre of main switch B. Check power source C. Shut machine of and reset motor circuit breaker D. Confirm all terminations are connected and secure E. Change and replace carbon brushes
Motor overheats or operates at a lower rate of speed or RPM	<ul style="list-style-type: none"> A. Motor overloaded during operation B. Carbon brushes are worn out and at fault 	<ul style="list-style-type: none"> A. Adjust the depth of cut to reduce the strain on the motor by removing less material B. Replace worn out motor brushes with new ones
Motor Shut off or stalls during operation	<ul style="list-style-type: none"> A. Depth of cut is to deep B. Motor breaker on machine has tripped C. Loose or poor connection causing an electrical short D. Electrical circuit breaker supplying the machine tripped E. Carbon brushes at fault due to wear 	<ul style="list-style-type: none"> A. Adjust the depth of cut to reduce the strain on the motor by removing less material B. Turn machine off and reset the breaker C. Replace or fix connections that have worn or become loose D. Reset the circuit breaker in your electrical panel supplying the machine E. Replace worn carbon brushes with new brushes.
Cutterhead making a squealing noise and slows when cutting specifically on startup	<ul style="list-style-type: none"> A. V belt is worn out B. Carbon brushes at fault due to wear 	<ul style="list-style-type: none"> A. Replace the worn out V belt with new belt B. Replace worn carbon brushes with new brushes
Infeed/outfeed rollers not turning	<ul style="list-style-type: none"> A. Sprocket or drive chain is worn, broken or requires adjustment or not connected 	<ul style="list-style-type: none"> A. Adjust drive chain and sprocket. If chain or sprocket is broken replace it
Vibration while running or cutting	<ul style="list-style-type: none"> A. Knives may be dull B. Belt may be damaged C. Cutterhead may be damaged or loose D. Cutterhead bearings may be worn 	<ul style="list-style-type: none"> A. Replace dull knives with new knives B. Replace damaged belt with new belt C. Replace or tighten the cutterhead as required D. Check and replace bearings with new
Boards feeding incorrectly through Jointer	<ul style="list-style-type: none"> A. Knives may be dull B. Feed roller may be worn, dirty, loose, or even poorly adjusted 	<ul style="list-style-type: none"> A. Replace dull knives with new knives B. Clean/ inspect rollers for wear and that they are secure and properly adjusted.

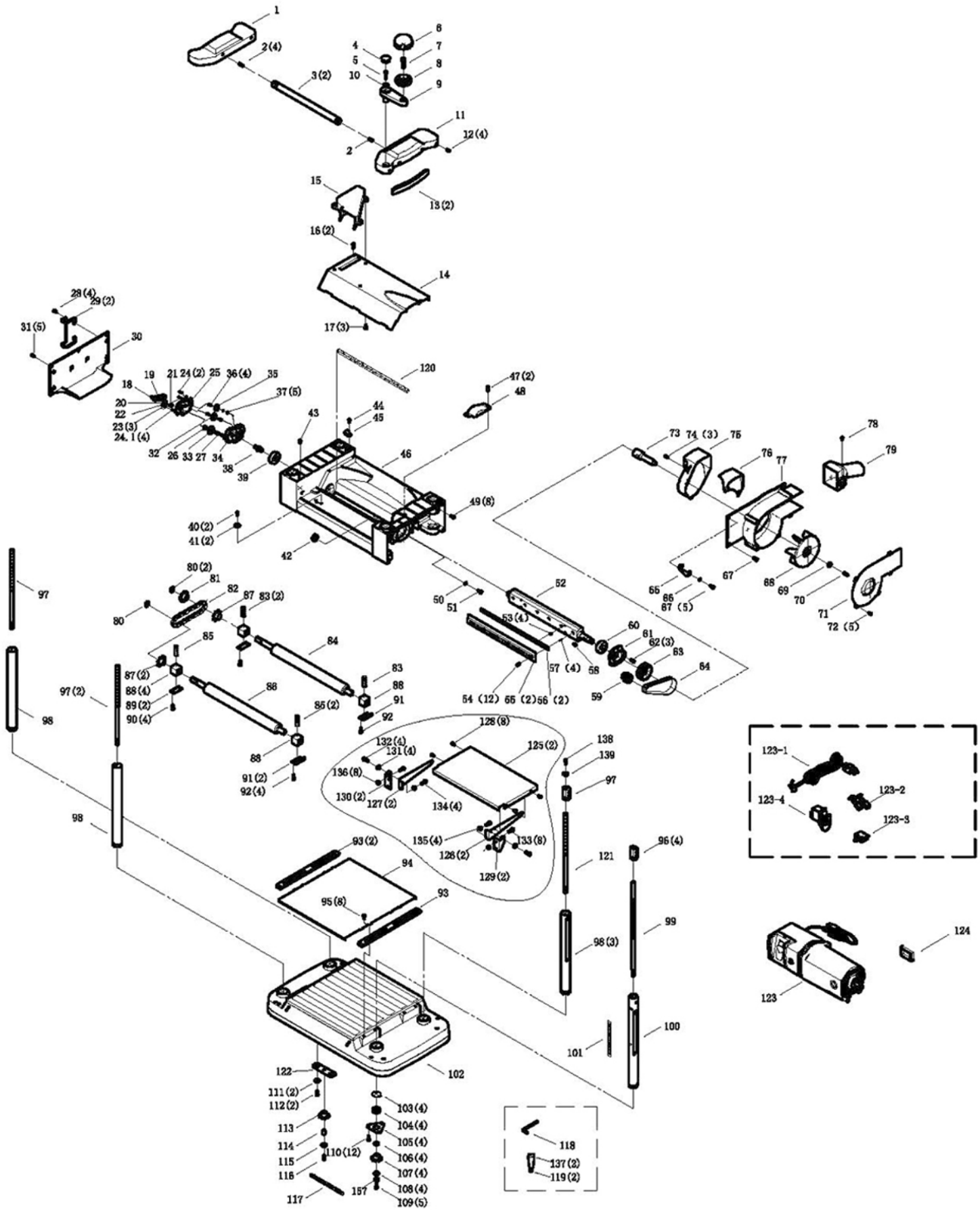

Part List for 22101

NO.	Part Name	Specification	Q'TY
1	Left Cap		1
2	Pin		4
3	Roller		2
4	Cap		1
5	Screw	M5×25	1
6	Handle Cover		1
7	Handle Shaft		1
8	Handle		1
9	Rocker		1
10	Spring Washer	φ5	
11	Right Cap		1
12	Screw	M6×6	4
13	Grip		2
14	Blade Guard		1
15	Air Duct		1
16	Screw	M5×10	2
17	Screw	ST4.2×9.5	3
18	Retaining Ring	φ15	1
19	Chain	410-27	1
20	Sprocket		3
21	Spacer		1
22	Screw	M5×35	1
23	Screw	M5×35	3
24	Screw	M5XP0.8X12L	2
24.1	Spring Washer	φ5	4
25	Gearbox Cover		1
26	Ball Bearing	6002-2Z	1
27	Shaft		1
28	Screw	M4×10	4
29	Cord Wrap Frames		2
30	Left Cover		1
31	Screw	M6×12	5
32	Gear		1
33	Gear		1
34	Gearbox		1
35	Gear		1
36	Washer	φ8Xφ14X0.1	5
37	Bushing		5

NO.	Part Name	Specification	Q'TY
38	Pinion		1
39	Ball Bearing	6203-2Z	1
40	Screw	M5×8	2
41	Serrated Washer	M5×8	2
42	Washer		1
43	Screw	M5×8	1
44	Screw	M5×10	1
45	Cable Clamp	UC-1.5	1
46	Carriage		1
47	Screw	M5×10	2
48	Belt Guard		1
49	Screw	M5×12	8
50	Flat Washer	φ8	1
51	Bolt	M8×25	1
52	Cutterhead		1
53	Pin		4
54	Screw	M6×16	12
55	Gib		2
56	Blade		2
57	Spring		4
58	Key	A5×10	1
59	Motor Pulley		1
60	Ball Bearing	6203-2Z	1
61	Bearing Retainer		1
62	Screw	M5×12	3
63	Cutterhead Pulley		1
64	V-Belt	135J6	1
65	Indicator		1
66	Flat Washer	φ6	1
67	Screw	M6×12	5
68	Fan		1
69	Flat Washer	φ6	1
70	Screw	M6×12 (Left teeth)	1
71	Fan Cover		1
72	Screw	M5×16	5
73	Fan Shaft		1
74	Screw	4.8×10	3
75	Dust Guide		1

NO.	Part Name	Specification	Q'TY
76	Elector		1
77	Fan Housing		1
78	Screw	M6×25	1
79	Dust Chute		1
80	Retaining Ring	φ15	2
81	Sprocket		1
82	Chain	410-26	1
83	Spring	2.4×17×35L-A	2
84	Outfeed Roller		1
85	Spring	2.2×17×30L-A	2
86	Infeed Roller		1
87	Sprocket		2
88	Retaining Bracket		4
89	Left Bracket		2
90	Screw	M5×10	4
91	Right Bracket		2
92	Screw	M5×10	4
93	Guide		2
94	Table Plate		1
95	Screw	M5×10	8
96	Elevating Screw Cap		4
97	Elevating Screw Rod		2
98	Column		3
99	Elevating Screw Rod		1
100	Column		1
101	Scale		1
102	Base		1
103	Ring	φ30	4
104	Ball Bearing	6000-2Z	4
105	Bearing Retainer		4
106	Spacer		4
107	Sprocket		4
108	Washer	φ4.3×φ16×2t	4
109	Screw	M4×12	5
110	Screw	M5×10	12
111	Flat Washer	φ5	2
112	Screw	M5×10	2
113	Sprocket		1

NO.	Part Name	Specification	Q'TY
114	Bushing		1
115	Flat Washer	φ6	1
116	Screw	M6×20	1
117	Chain	35-156	1
118	Hex Wrench	1127/2127-A	1
119	Magnet		2
120	Sprong		1
121	Elevating Screw Rod		1
122	Plate		1
123	Motor	14AWGX3C, 120V/60HZ/2HP/15A	1
124	Sprong	14×60×90	1
125	Extension Table		2
126	Set Plate (Right)		2
127	Set Plate (Left)		2
128	Screw	M4×6	8
129	Bracket (Right)		2
130	Bracket (Left)		2
131	Bushing		4
132	Screw	M6×12	4
133	Screw	M6×16	8
134	Screw	M5×20	4
135	Nut	M5	4
136	Nut	M6	8
137	Magnet Cover		2
138	Screw	M5×10	1
139	Flat Washer	φ5	1